



## Signage & Vehicle Brand Style Guide



## Signage and Vehicle Brand Style Guide

The purpose of this brand style guide is to have a campus-wide unified and comprehensive look for all building identity, directional, wayfinding, address and LED panel signage on University buildings, walkways, entrances, etc.

This guide is part of the brand platform set that helps each of the University of Delaware's communications efforts to work in concert. A brand platform is a set of guidelines that serves as a common foundation for brand development and governs all aspects of a brand's visual elements, messages and implementation. To be successful, every entity in the UD community needs to help deliver the UD brand identity and message through its programs and activities.

## Color Palettes

Color plays a critical role in strengthening the overall impact of the University of Delaware identity. It is perhaps the most significant identifier that the University uses. The consistent use of color is a vital part of communicating the University's brand.

The official blue and yellow are the University of Delaware's primary colors for use in print and electronic communications. Accent or secondary colors are used to complement UD's blue and yellow, but should not be used as primary or stand-alone elements of the color palette.

The logo may appear in the approved primary colors, or reversed in white out of a field of primary color.

When printing, spot colors (Pantone) should be used. When printing in full color (four-color process), the CMYK mix provided in the palette should be used. Automatic conversion of the spot color within an application can result in an incorrect mix.

## Primary colors:

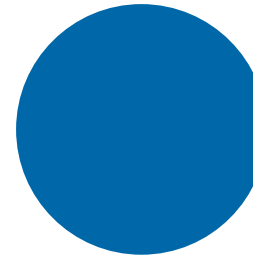

PMS 2945 C  
C 100 + M 38 + Y 0 + K 15  
R 0 + G 83 + B 159  
HEX: 00539f

*When using uncoated stock, use  
PMS 3005 U.*

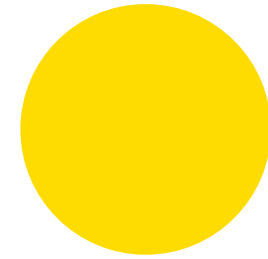





PMS 109 C  
C 0 + M 9 + Y 94 + K 0  
R 255 + G 210 + B 0  
HEX: ffd200

*When using uncoated stock, use  
PMS 108 U.*

## Official Color Charts

Below is a list of the official color selections for the University of Delaware's logos, by acceptable color model.

### Pantone Coated Color Equivalents:

COLOR NAME	COLOR	PANTONE	Process/CMYK	RGB	HEXADECIMAL
Delaware Blue		2945C	100-38-0-15	0-83-159	#00539f
Delaware Yellow-Gold		109C	0-9-94-0	255-210-0	#ffd200
YoUDee Blue		299C	87-19-0-0	0-160-223	#00a0df
Delaware Red		187C	0-91-72-24	175-30-45	#af1e2d
Delaware Gray		Cool Gray 4C	0-0-0-28	189-189-189	#bdbdbd

Trademarks of the University of Delaware may appear in full-color or one-color versions, as shown throughout The Collegiate Licensing Company (CLC) site. They should appear only as shown or otherwise permitted by the CLC.

### Thread Colors:

COLOR NAME	PANTONE	Madeira	RA	GS/SULKY
Delaware Blue	2945C	1076	2220	1535
Delaware Yellow-Gold	109C	1124	2462	1187
YoUDee Blue	299C	1297	2730	861
Delaware Red	187C	1147	2263	1147
Delaware Gray	Cool Gray 4C	1011	2592	1327

### Acrylic and Powder Coating Colors:

COLOR NAME	PANTONE	GEMINI	DRYLAC	-
Delaware Blue	2945C	2860	RAL5005	-
Delaware Yellow-Gold	109C	2037	RAL1018	-
YoUDee Blue	299C	3000	-	-
Delaware Red	187C	2793	-	-
Delaware Gray	Cool Gray 4C	8807	-	-

### Opaque Vinyl Colors:

COLOR NAME	PANTONE	3M Opaque	ORACAL Premium 851	ORACAL HP 751	AVERY A6 Opaque	AVERY A9 Opaque HP
Delaware Blue	2945C	Vivid Blue 180C-17	509 Sea Blue	057 Traffic Blue	Vivid Blue A6570-0	Vivid Blue A9570-0
Delaware Yellow-Gold	109C	Bright Yellow (109C) 180C-15	209 Maize Yellow	209 Maize Yellow	Primrose Yellow A6110-0	Lemon Zest (109C) A9113-0
YoUDee Blue	299C	Olympic Blue 180C-47	547 Fjord Blue	517 Euro Blue	Olympic Blue A6530-0	Olympic Blue A9530-0
Delaware Red	187C	Geranium 180C-63	031 Red	031 Red	True Red A6332-0	Fire Red A9345-0
Delaware Gray	Cool Gray 4C	Medium Gray 180C-31	730 Simple Grey	074 Middle Grey	Medium Gray A6035-0	Medium Gray A9035-0

### Reflective Vinyl Colors:

COLOR NAME	PANTONE	3M Scotchlite Reflective	ORACAL Series 550 Reflective	AVERY Reflective
Delaware Blue	2945C	Blue 680-75, 680CR-75	Blue 050	Blue A7822-R
Delaware Yellow-Gold	109C	Yellow 680-71, 680CR-71	Yellow 020	Yellow A7812-R
Delaware White	White	White 680-10, 680CR-10	White 010	White A7801-R
Delaware Gold [Vehicles Only]	872C	Gold 680-64, 680CR-64	Gold 091	Gold A7807-R

Use of all marks requires written approval prior to production. The name and marks of the University of Delaware are controlled under a licensing program administered through the CLC.





## Signage Brand Style Guide

### Signage

Campus signage, from building identification to directional signs, is another way in which UD maintains a consistent brand identity. This section outlines the standards and guidelines for various types of University signage.

All exterior building and directional signage should be developed in cooperation with the University of Delaware's Planning and Project Delivery department and the UD Architect:

142 General Services Building  
222 S. Chapel St.  
Newark, DE 19716-1744  
Fax: 302-831-8294  
Telephone: 302- 831-1744  
Email: [ud-fpc@udel.edu](mailto:ud-fpc@udel.edu)

To request a new sign, please submit a completed "University of Delaware Request for Services Form" to the Planning and Project Delivery department.

The Sign Request Form may be found online in Web Forms or at this link:  
[https://udapps.nss.udel.edu/webforms/embtform?wf\\_id=1106&wf](https://udapps.nss.udel.edu/webforms/embtform?wf_id=1106&wf)



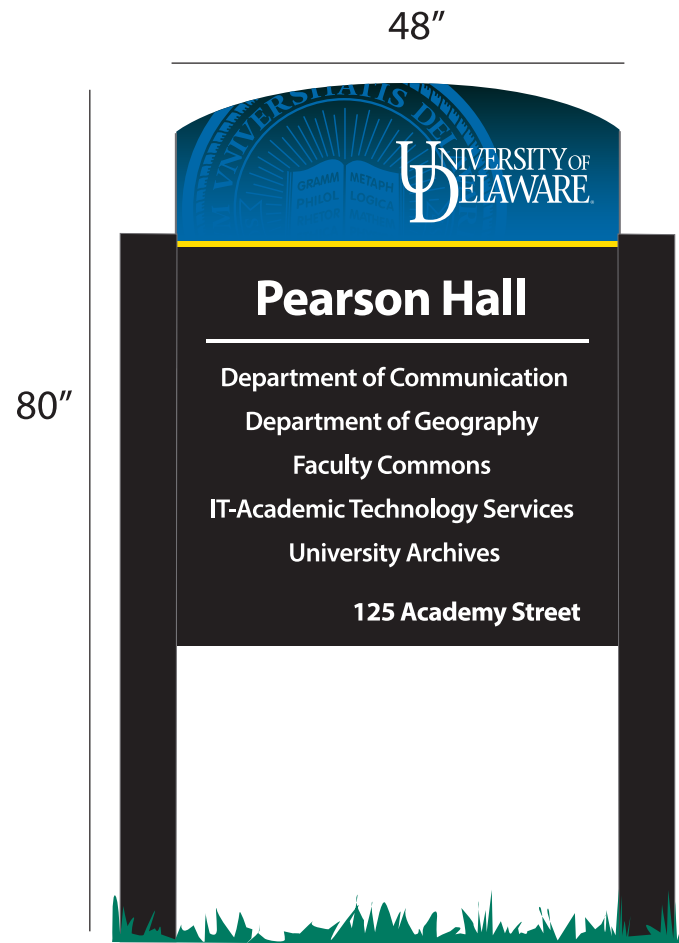

roadway building identity  
48 x 80  
Campus-wide

**Double-Sided Aluminum Fabricated Building Identity Sign, to include:**

- Overall Size - 60"h x 48"w
- (1) Header Panel - 18"h x 48"w
- Full Color Graphics File - Orafol vinyl with laminate.
  - full header-blue to black gradient with UD seal ghosted and white UD Primary logo
- (1) Directional Panel - 42"h x 48"w
- .080" Painted matte black aluminum facing over 1" square aluminum frame with VHB tape and Weld-On (2 part Chemical Adhesive)
- Posts: 3" x 3" square, aluminum painted matte black
- Single Colors - 3M Scotchcal 50 Vinyl Graphics
  - reflective white
  - bright yellow 180C-15

**Installation:**

- Installation of above between (2) 3" x 3" painted aluminum posts in dirt set in concrete
- Height to top of the sign - approx. 80"
- 12" diameter x 36" deep footers
- Installed perpendicular to the building for ease of reading both sides/directions
- All building tenants are listed in alphabetical order, with the exception of the following instances:
  - approved units that fall within a college or department, and should therefore be listed underneath the parent entity
  - if occupancy is known to be temporary, unit will be listed last to minimize sign repair/disruption.

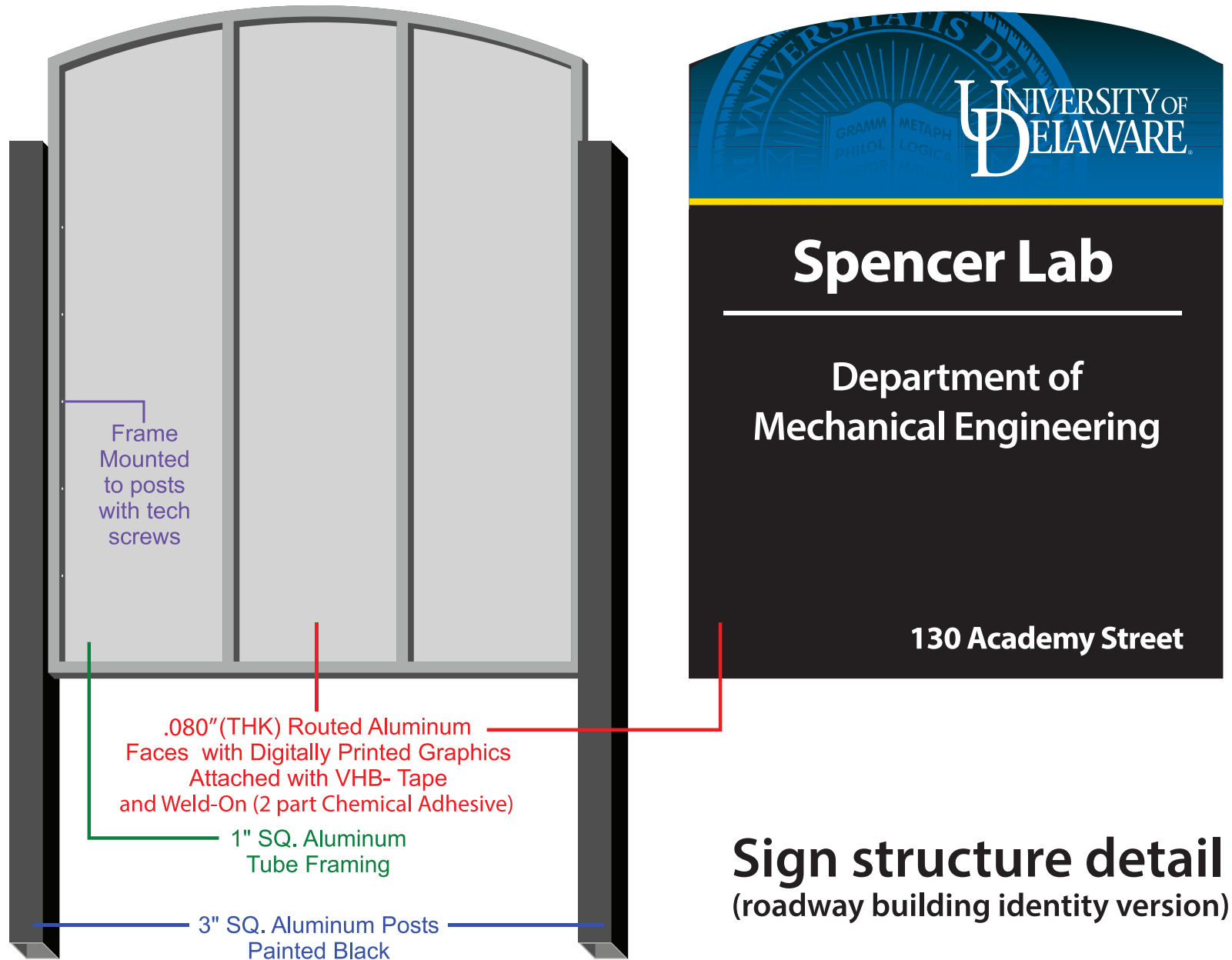

## Construction Notes/Specs

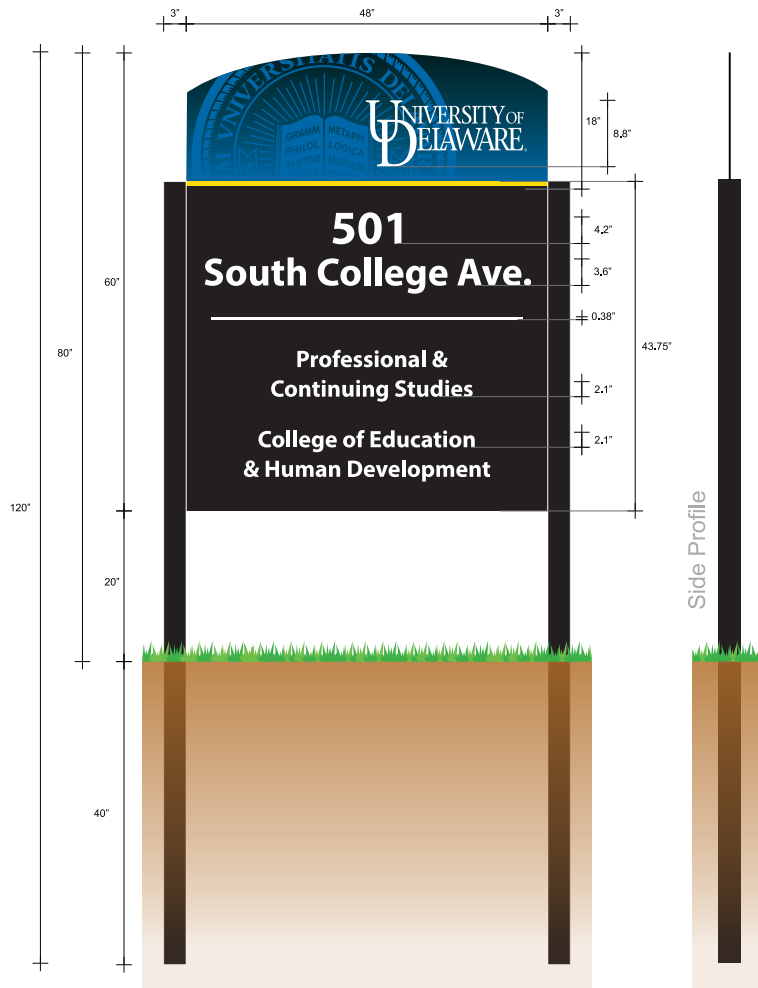

Double Sided Aluminum Fabricated Building Identity Sign

- Overall Height - 80" h (from grade)
- Overall Width - 54" w (post to post)
- 0.080" Routed aluminum faces with cad cut vinyl and digital prints
- 3" Square posts
- Posts painted matte black
- Full Color Graphics File - Orafol vinyl with laminate.
  - blue to black gradient with UD seal ghosted and white UD Primary logo
- 3M Cad cut white reflective vinyl directional type
- 3M high performance non-reflective vinyl - horizontal stripes below header panel
- Sign installed using direct burial in ground with 3000 psi ready mix concrete

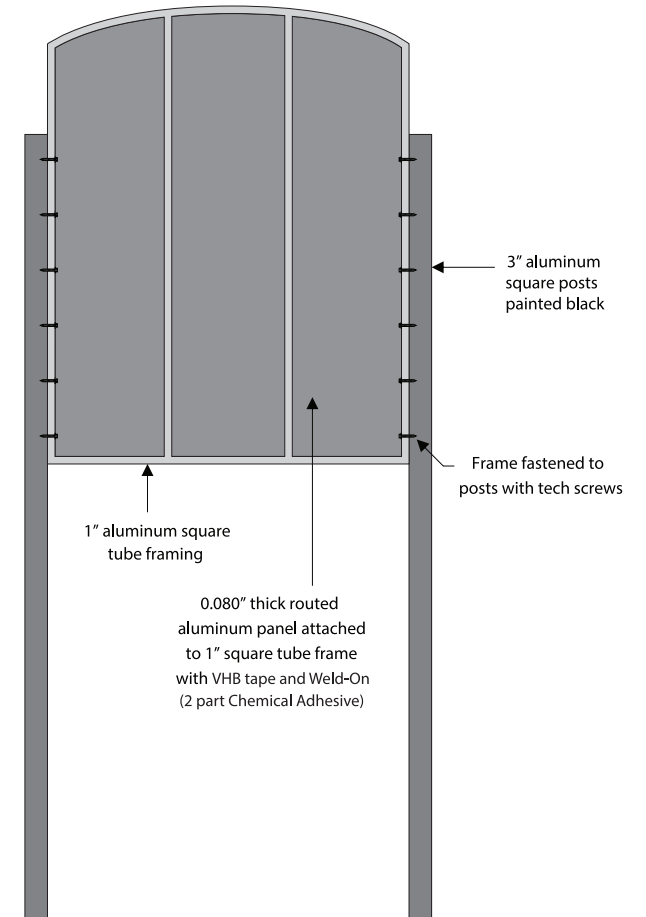

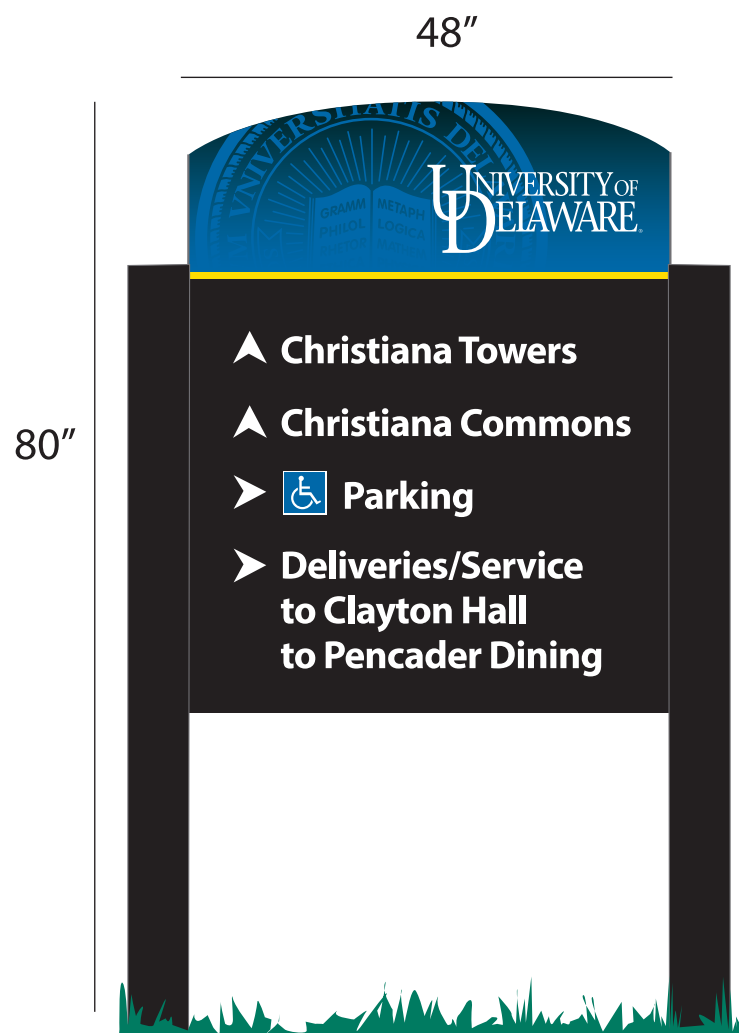

roadway directional  
48 x 80  
Campus-wide

**Double-Sided Aluminum Fabricated Wayfinding Sign, to include:**

- Overall Size - approx. 60"h x 48"w
- (1) Header Panel - 18"h x 48"w
- Full Color Graphics File - Orafol vinyl with laminate.
  - full header-blue to black gradient with UD seal ghosted and white UD Primary logo
- Directional Panels - 42" x 48"w with options for larger panels
- .080" Painted matte black aluminum facing over 1" square aluminum frame with VHB tape and Weld-On (2 part Chemical Adhesive)
- Posts: 3" x 3" square, aluminum painted matte black
- Single Colors - 3M Scotchcal 50 Vinyl Graphics
  - white
  - bright yellow 180C-15
  - vivid blue 180C-17

**Installation:**

- Installation of above between (2) 3" x 3" painted aluminum posts in dirt set in concrete
- Height to top of the sign - approx. 80"
- 12" diameter x 36" deep footers
- Installed perpendicular to the building for ease of reading both sides/directions

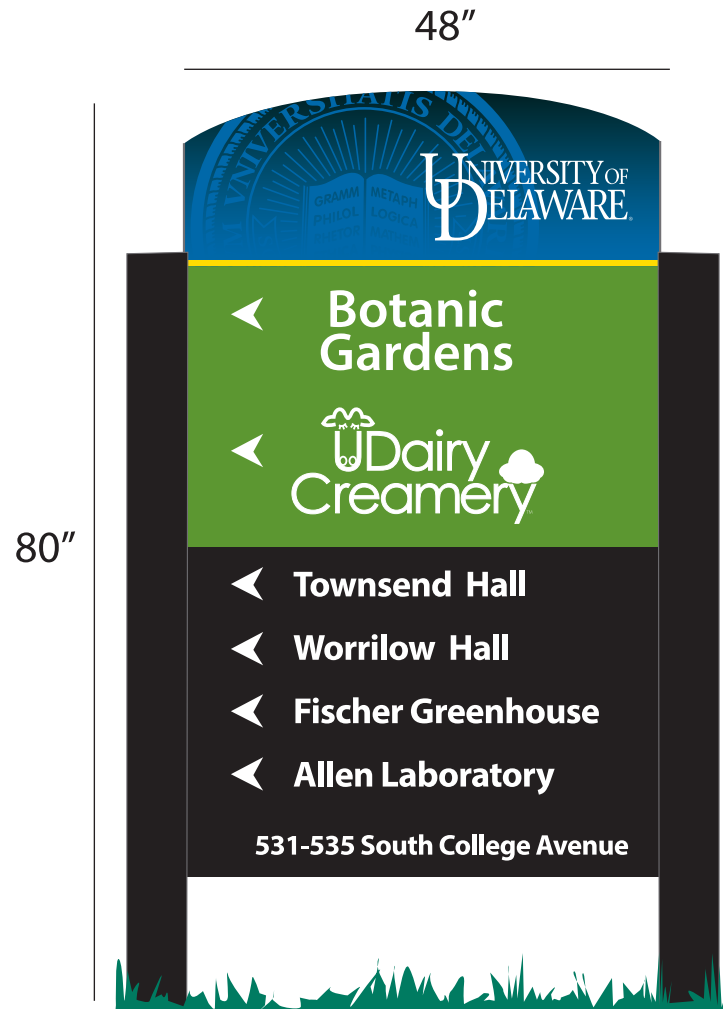

roadway directional  
specialty  
48 x 80  
Campus-wide

**Double-Sided Aluminum Fabricated Wayfinding Sign, to include:**

- Overall Size - 72"h x 48"w
- (1) Header Panel - 18"h x 48"w
- Full Color Graphics File - Orafol vinyl with laminate.
  - full header-blue to black gradient with UD seal ghosted and white UD Primary logo
- (2) Logo Directional Panels - 12"h x 48"w each (varies)
- Directional Panels - misc. x 48"w
- .080" Painted matte black aluminum facing over 1" square aluminum frame with VHB tape and Weld-On (2 part Chemical Adhesive)
- Posts: 3"x 3" square, aluminum painted matte black
- Single Colors - 3M Scotchcal 50 Vinyl Graphics
  - reflective white
  - bright yellow 180C-15
  - apple green 180C-196

**Installation:**

- Installation of above between (2) 3" x 3" painted aluminum posts in dirt set in concrete
- Height to top of the sign - approx. 80"
- 12" diameter x 36" deep footers
- Installed perpendicular to the building for ease of reading both sides/directions

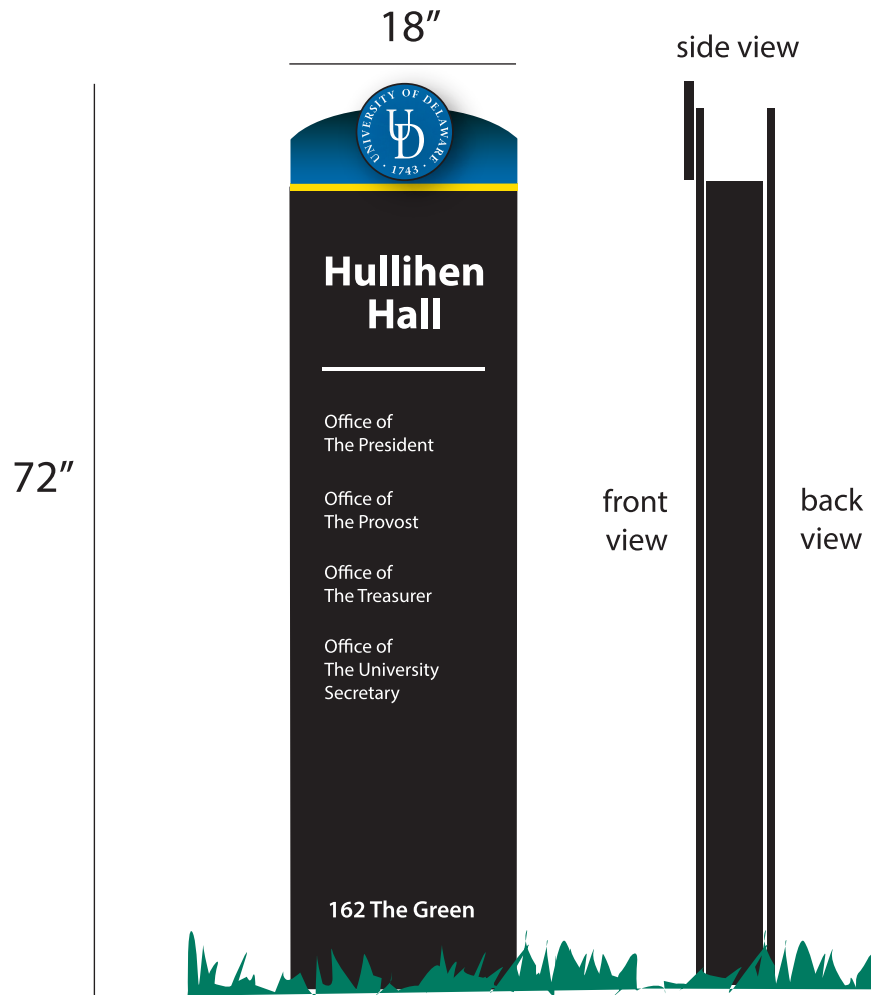

walking building identity  
option 1  
18 x 72  
The Green

**Single-Sided Aluminum Fabricated Building Identity Sign, to include:**

- Overall Size - 72"h x 18"w
- (1) Header Panel - 9"h x 18"w (including height of the logo medallion)
- (1) Cast aluminum UD medallion (blue/white), 8" dia
- (1) Directional Panel - 63"h x 18"w
- .125" Painted matte black aluminum
- Full Color Graphics File - 3M IJ180C Control Tac vinyl with 3M8518 Over-laminate Vinyl Graphics
  - full header-blue to black gradient with separately applied 8" UD logo medallion
- Single Colors - 3M Scotchcal 50 Vinyl Graphics
  - reflective white
  - bright yellow 180C-15
  - vivid blue 180C-17

**Installation:**

- Installation of above on (2) 4" x 4" painted aluminum square posts in dirt set in concrete
- Height to top of the sign - approx. 72"
- installation parallel to the building

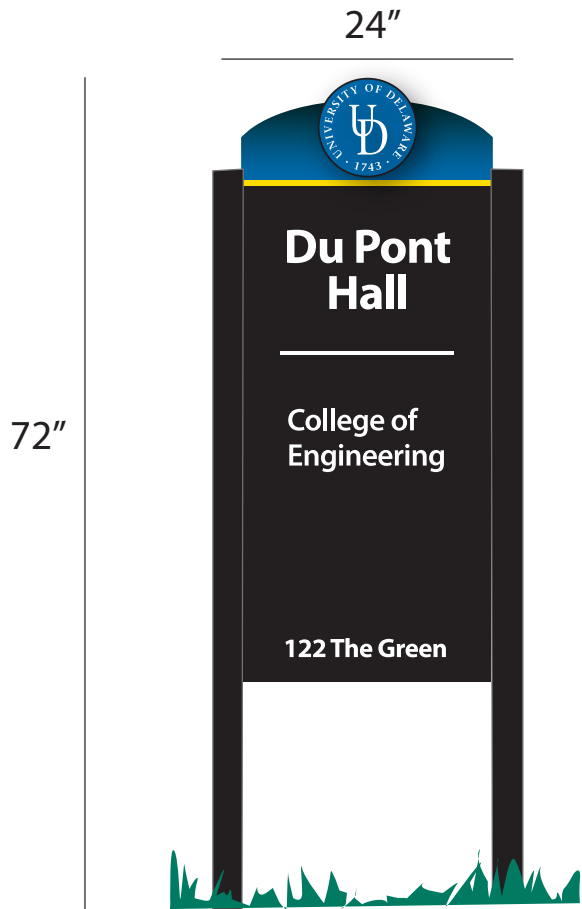

walking building identity  
option 2  
24 x 72  
The Green

### Single-Sided Aluminum Fabricated Building Identity Sign, to include:

- Overall Size - 51" h x 24" w
- (1) Header Panel - 9" h x 24" w (including height of the logo medallion)
- (1) Cast aluminum UD medallion (blue/white), 8" diameter
- Full Color Graphics File - Orafol vinyl with laminate.
  - full header-blue to black gradient with UD seal ghosted and white UD Primary logo
  - separately applied 8" UD logo medallion
- (1) Directional Panel - 42" h x 24" w
- .080" Painted matte black aluminum facing over 1" square aluminum frame with VHB tape and Weld-On (2 part Chemical Adhesive)
- Posts: 3" x 3" square, aluminum painted matte black
- Single Colors - 3M Scotchcal 50 Vinyl Graphics
  - reflective white
  - bright yellow 180C-15

#### Installation:

- Installation of above between (2) 3" x 3" painted aluminum posts in dirt set in concrete
- Height to top of the sign - approx. 72"
- 12" diameter x 36" deep footers
- Installed parallel to the building unless otherwise noted for double-sided option.
- All building tenants are listed in alphabetical order, with the exception of the following instances:
  - approved units that fall within a college or department, and should therefore be listed underneath the parent entity
  - if occupancy is known to be temporary, unit will be listed last to minimize sign repair/disruption.

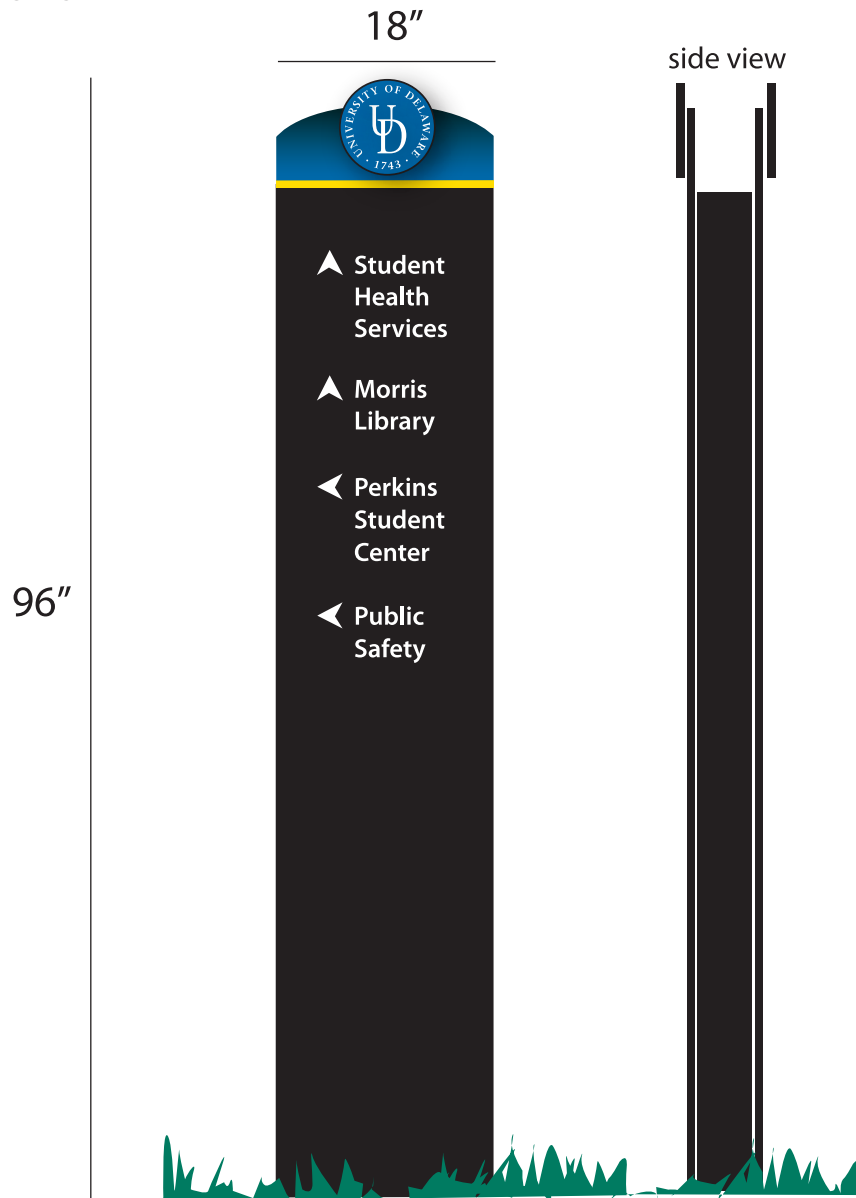

walking directional  
18 x 96  
The Green

**Double-Sided Aluminum Fabricated Building Identity Sign, each side to include:**

- Overall Size - 96"h x 18"w
- (1) Header Panel - 9"h x 18"w (including height of the logo medallion)
- (2) Cast aluminum UD medallion (blue/white), 8" diameter
- (1) Directional Panel - 87"h x 18"w
- .125" Painted matte black aluminum
- Full Color Graphics File - 3M IJ180C Control Tac vinyl with 3M8518 Over-laminate Vinyl Graphics
  - full header-blue to black gradient with separately applied 8" UD logo medallion
- Single Colors - 3M Scotchcal 50 Vinyl Graphics
  - reflective white
  - bright yellow 180C-15
  - vivid blue 180C-17

**Installation:**

- Installation of above on (2) 4" x 4" painted aluminum square posts in dirt set in concrete
- Height to top of the sign - approx. 96"



**Trabant University Center LED double-sided sign**



104"



86"

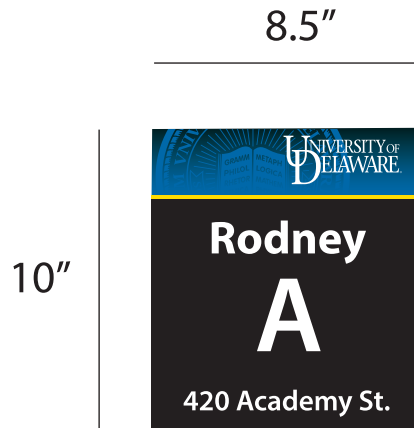

building  
address  
small  
8.5 x 10  
Campus-wide

This style sign is best used for identifying doors or entryways of residence halls.

**Single-Sided Aluminum Fabricated Building Address Sign, to include:**

- Overall Size - 10"h x 8.5"w
- (1) Header Panel - 2.25"h x 8.5"w
- (1) Address Panel - 7.75"h x 8.5"w
- .25" Painted matte black aluminum
- Full Color Graphics File - 3M IJ180C Control Tac vinyl with 3M8518 Over-laminate Vinyl Graphics
  - full header-blue to black gradient with UD seal ghosted and white UD Primary logo
- Single Colors - 3M Scotchcal 50 Vinyl Graphics
  - reflective white
  - bright yellow 180C-15
  - vivid blue 180C-17

**Installation:**

- Installation of above pin-mounted flat on wall at location.
- Installation 60" AFF



building  
address  
12 x 14.5

This style sign is best used for main entrances, when viewed from a walkway or in extreme space situations.

**Single-Sided Aluminum Fabricated Building Address Sign, to include:**

- Overall Size - 14.5"h x 12"w
- (1) Header Panel - 3.25"h x 12"w
- (1) Address Panel - 11.25"h x 12"w
- .25" Painted matte black aluminum
- Full Color Graphics File - 3M IJ180C Control Tac vinyl with 3M8518 Over-laminate Vinyl Graphics
  - full header-blue to black gradient with UD seal ghosted and white UD Primary logo
- Single Colors - 3M Scotchcal 50 Vinyl Graphics
  - reflective white
  - bright yellow 180C-15
  - vivid blue 180C-17

**Installation:**

- Installation of above pin-mounted flat on wall at location.
- Installation 60" AFF

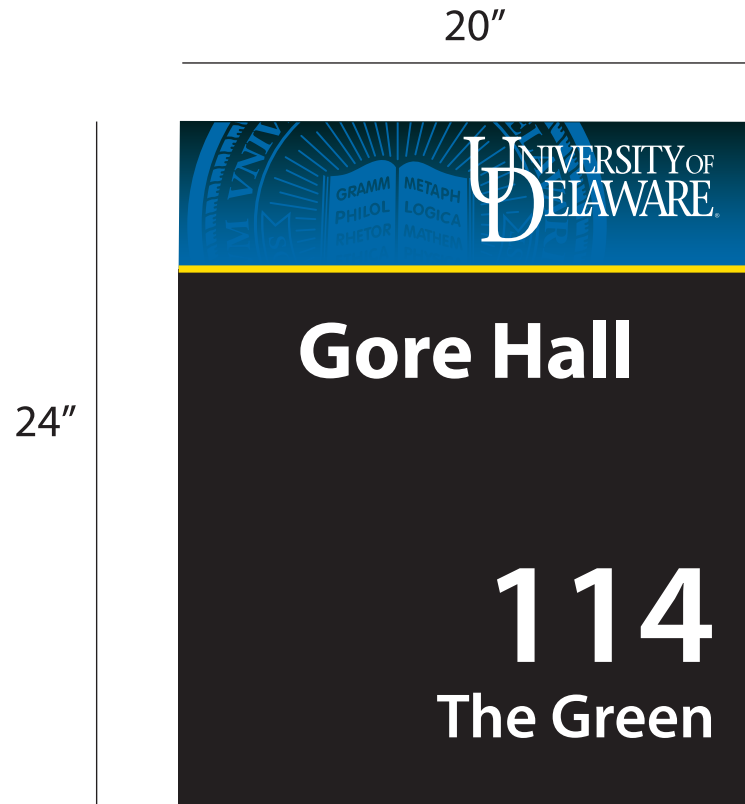

building  
address  
20 x 24

Campus-wide

This style sign is best used for main entrances, when viewed from a roadway or extreme distance, such as The Green.

**Single-Sided Aluminum Fabricated Building Address Sign, to include:**

- Overall Size - 24"h x 20"w
- (1) Header Panel - 5.5"h x 20"w
- (1) Address Panel - 18.5"h x 20"w
- .25" Painted matte black aluminum
- Full Color Graphics File - 3M IJ180C Control Tac vinyl with 3M8518 Over-laminate Vinyl Graphics
  - full header-blue to black gradient with UD seal ghosted and white UD Primary logo
- Single Colors - 3M Scotchcal 50 Vinyl Graphics
  - reflective white
  - bright yellow 180C-15
  - vivid blue 180C-17

**Installation:**

- Installation of above pin-mounted flat on wall at location.
- Installation 60" AFF

## UD Health 72x120 pylon building signage



### Colors



Intense Blue (180C-47)

Pantone 2945C

Blue



white

white

white

3M Controltac Plus Graphic Film

Pantone Color Matching System

Acrylic Polyurethane

**Main Title Font/Typestyle: Myriad Pro Bold**  
**Name Font/Typestyle: Myriad Pro Semibold**  
**Number Font/Typestyle: Myriad Pro Regular**  
**Logo: Official UD Health lockup**



Background color:  
Pantone Cool Grey 3

Top view of pylon sign.



## UD Health Specialty signage for internal/UD Public Entities



**Colors**

		3M Controltac Plus Graphic Film
Intense Blue (180C-47)	White	
Pantone 2945C	Pantone White	Pantone Color Matching System
Blue	White	Acrylic Polyurethane

Font/Typestyle: Myriad Pro Semibold

Logo: Official UD Health lockup

Top view of pylon sign.

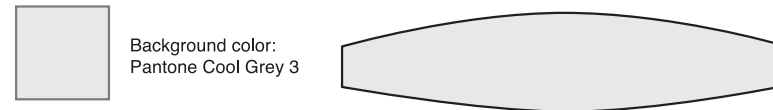

## STAR Campus - building address 60" pylon signage (street side)



### Colors



Intense Blue (180C-47)

Pantone 2945C

Blue



Reflective White

Pantone White

White

3M Controltac Plus Graphic Film

Pantone Color Matching System

Acrylic Polyurethane

**Number Font: Myriad Pro Regular**  
**Typestyle: Myriad Pro Semibold**

**Logo: Official STAR Campus logo**  
**Official UD Primary logo**



Background color:  
Pantone Cool Grey 3

Top view of pylon sign.



# STAR Campus 72x120 pylon building signage

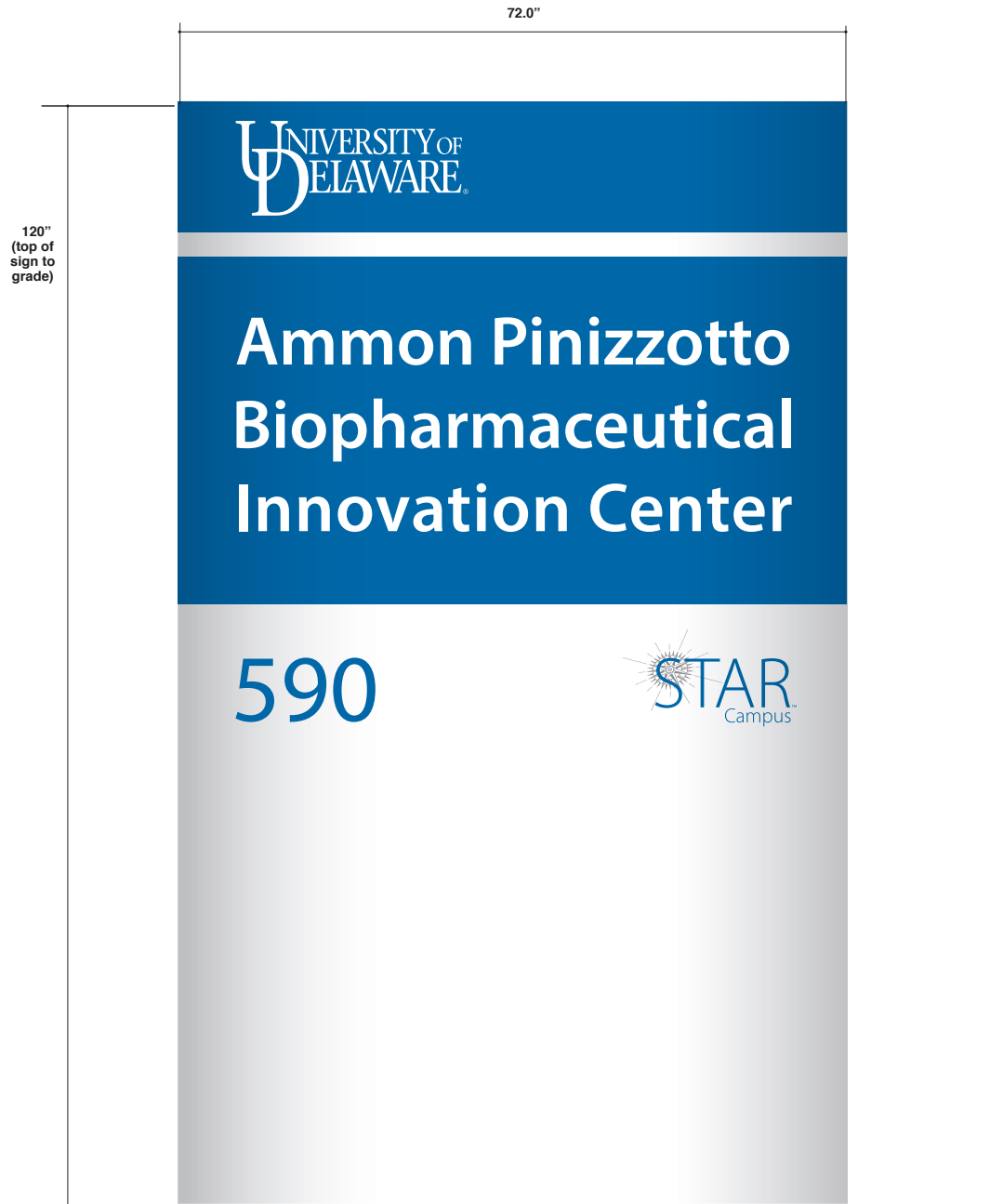

## Colors



Intense Blue (180C-47)

Pantone 2945C

Blue



Medium Gray (180C-31)

Pantone Cool Grey 8C

Cool Grey 80%



white

white

white

3M Controltac Plus Graphic Film

Pantone Color Matching System

Acrylic Polyurethane

**Main Title Font/Typestyle: Myriad Pro Bold**  
**Name Font/Typestyle: Myriad Pro Semibold**  
**Number Font/Typestyle: Myriad Pro Regular**  
**Logo: Official STAR Campus logo**  
**Official UD Primary logo**



Background color:  
Pantone Cool Grey 3

Top view of pylon sign.





## UD Health LED double-sided sign



Custom Fabricated Double-Sided sign with Electronic Message Center, to include:

### ID Header Sign

- Overall Dimension - 36"h x 123"w x 26" deep
- All Aluminum Construction
- Aluminum Dimensional Trim Top & Bottom
- 1-Color Matthews Painted Finish – Color - TBD
- LED Illumination
- 3/16" Thick White Polycarbonate Facing
- Translucent Vinyl Lettering / Graphics
- UL Listed and Approved

### Electronic Message Center

- Double-Sided
- Vantage 20mm 72 x 156 Full Color LED Display
- Full Color Pixel Configuration (1R, 1G, 1B)
- 281 Trillion Colors
- 57" x 123" Active Viewing Window

- Aluminum perforated mesh endcaps painted black
- 10,000+ Brightness Level (Nits)
- 160 Degree Viewing Angle
- Wireless Data Connection
- Complete Scheduling Software
- On Site Setup and Training
- 7 Year Manufacturer's Warranty (Parts & Labor)
- SM Infinity Software (Cloud Base)

### Installation

- Sign vendor will be responsible for the delivery and Installation of the above mentioned sign.

### Permitting

- Sign Vendor will be responsible for obtaining the required permits by the City of Newark for the sign installation.

\*\*NOTE: Electrical service for the sign will be provided by others.

# STAR Campus address signage

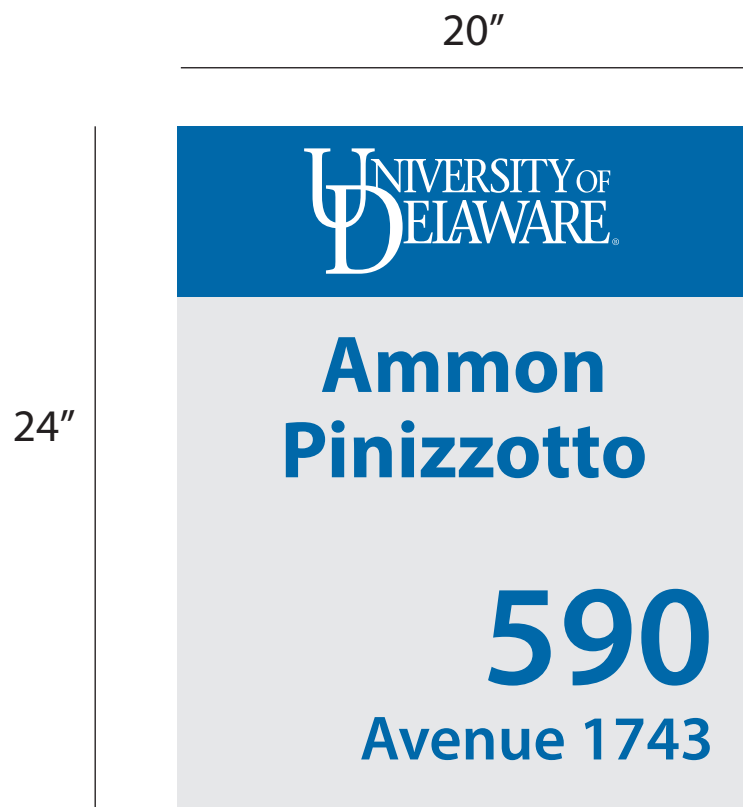

building  
address  
20 x 24  
Star Campus

## Single-Sided Aluminum Fabricated Building Address Sign, to include:

### Colors



Intense Blue (180C-47)

Pantone 2945C

Blue



White

Pantone White

White



Pearl Gray

Pantone Cool Gray 2C

White

3M Controltac Plus Graphic Film

Pantone Color Matching System

Acrylic Polyurethane

Font/Typestyle: Myriad Pro Semibold

Logo: Official UD Primary logo

- Overall Size - 24"h x 20"w

- .25" Pantone Cool Gray 3C vinyl applied to aluminum

- Single Colors - 3M Scotchcal 50 Vinyl Graphics

- reflective white
- bright yellow 180C-15
- vivid blue 180C-17

### Installation:

- Installation of above pin-mounted flat on wall at location.

## UD Downtown Building Sign (Wilmington, DE)

### Colors



A9001-T

White



A9561-T

Pantone 3005C



A9566-T

Pantone 2945C

Avery Translucent A6 Film

Pantone Color Matching System



UD SIGNAGE

**24" Parking Sign (CENTRAL Lot)**

Colors

White (5000)	Green (680-66, 680CR-66)	Blue (680-75, 680CR-75)	Aqua 180C-176	ScotchBrite Reflective Graphic Film
	Pantone 342C	Pantone 2945C	Pantone 3285C	Pantone Color Matching System
White	Green	Blue	Aqua	Acrylic Polyurethane

Font: Helvetica Bold CAPS, no size distortion

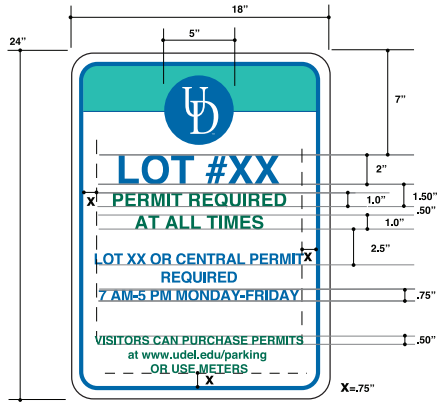

**24" Parking Sign (GOLD Lot)**

Colors

White (5000)	Green (680-66, 680CR-66)	Blue (680-75, 680CR-75)	Yellow (680-71, 680CR-71)	ScotchBrite Reflective Graphic Film
	Pantone 342C	Pantone 2945C	Pantone 109C	Pantone Color Matching System
White	Green	Blue	Yellow	Acrylic Polyurethane

Font: Helvetica Bold CAPS, no size distortion

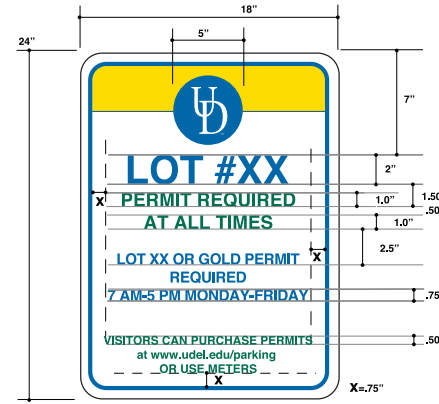

**24" Parking Sign (GRAY Lot)**

Colors

White (5000)	Green (680-66, 680CR-66)	Blue (680-75, 680CR-75)	Gray 180C-31	ScotchBrite Reflective Graphic Film
	Pantone 342C	Pantone 2945C	Pantone Cool Gray 4C	Pantone Color Matching System
White	Green	Blue	Gray	Acrylic Polyurethane

Font: Helvetica Bold CAPS, no size distortion

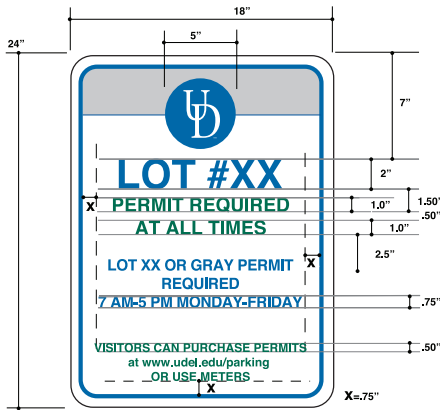

**24" Parking Sign (Pearson Lot)**

Colors

White (5000)	Green (680-66, 680CR-66)	Blue (680-75, 680CR-75)	Violet 7725-68	ScotchBrite Reflective Graphic Film
	Pantone 342C	Pantone 2945C	Pantone 257C	Pantone Color Matching System
White	Green	Blue	Violet	Acrylic Polyurethane

Font: Helvetica Bold CAPS, no size distortion

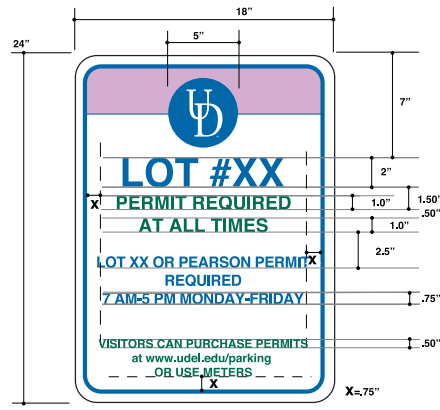

**24" Parking Sign (RED Lot)**

Colors

White (5000)	Green (680-66, 680CR-66)	Blue (680-75, 680CR-75)	Red 680-82	ScotchBrite Reflective Graphic Film
	Pantone 342C	Pantone 2945C	Pantone 187C	Pantone Color Matching System
White	Green	Blue	Red	Acrylic Polyurethane

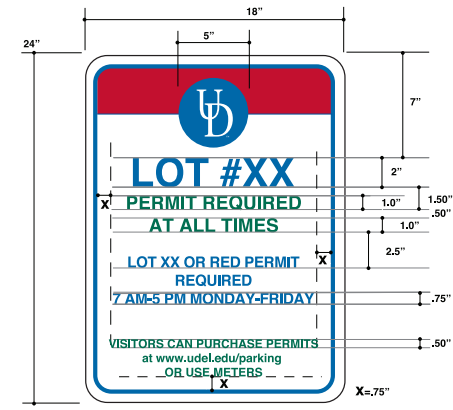

Font: Helvetica Bold CAPS, no size distortion



### 30" Public Parking Lot Sign

### 30" Parking Lot Sign

**Colors**

			
White 3M 5100 (reflective)	Green (680-56, 680CR-56)	Blue 680-75, 680CR-75)	Scotchlite Reflective Graphic Film
	Pantone 342C	Pantone 2945C	Pantone Color Matching System
White	Green	Blue	Acrylic Polyurethane

**Font**  
Helvetica Bold CAPS, no size distortion

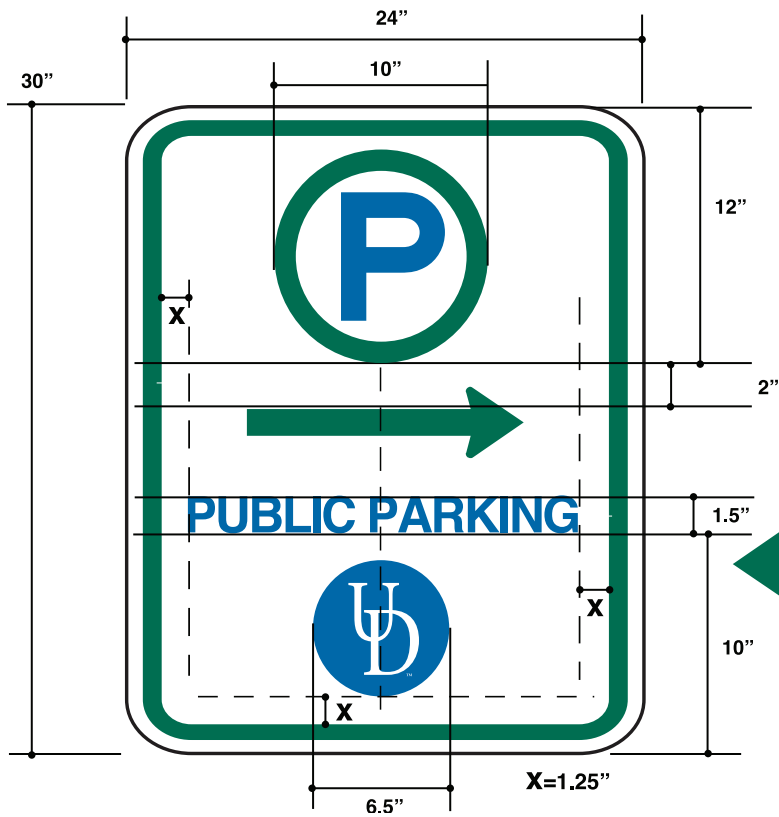

OPTIONS

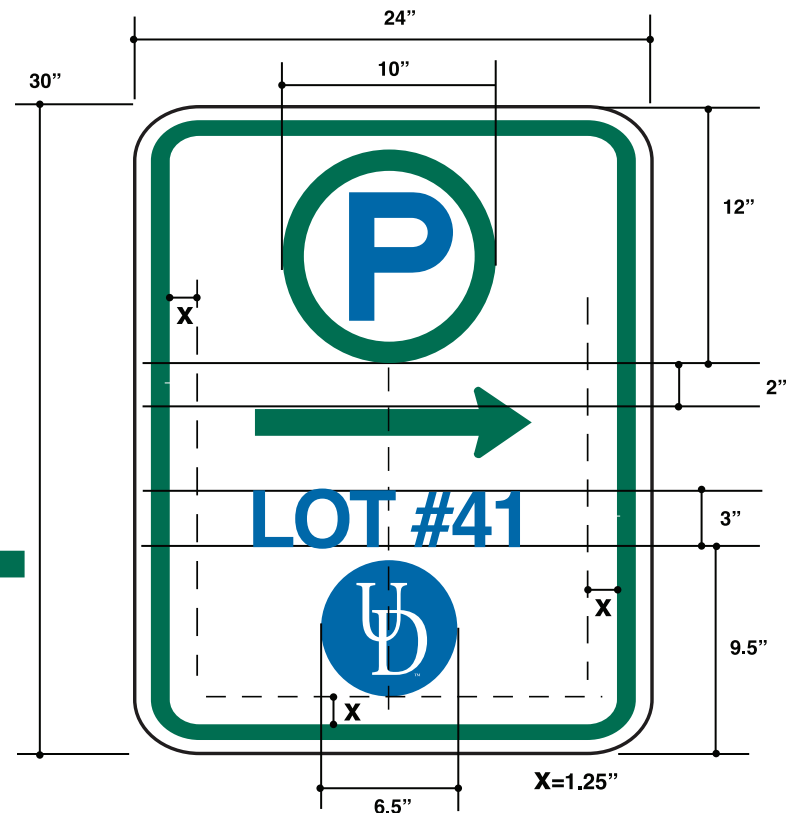

## 18" Service Vehicle Sign

### Colors



White 3M 5100 (reflective)	Intense Blue (180C-47)	3M Controllac Plus Graphic Film
White	Pantone 2945C	Pantone Color Matching System
White	Blue	Acrylic Polyurethane

### Font

Helvetica Bold CAPS, no size distortion

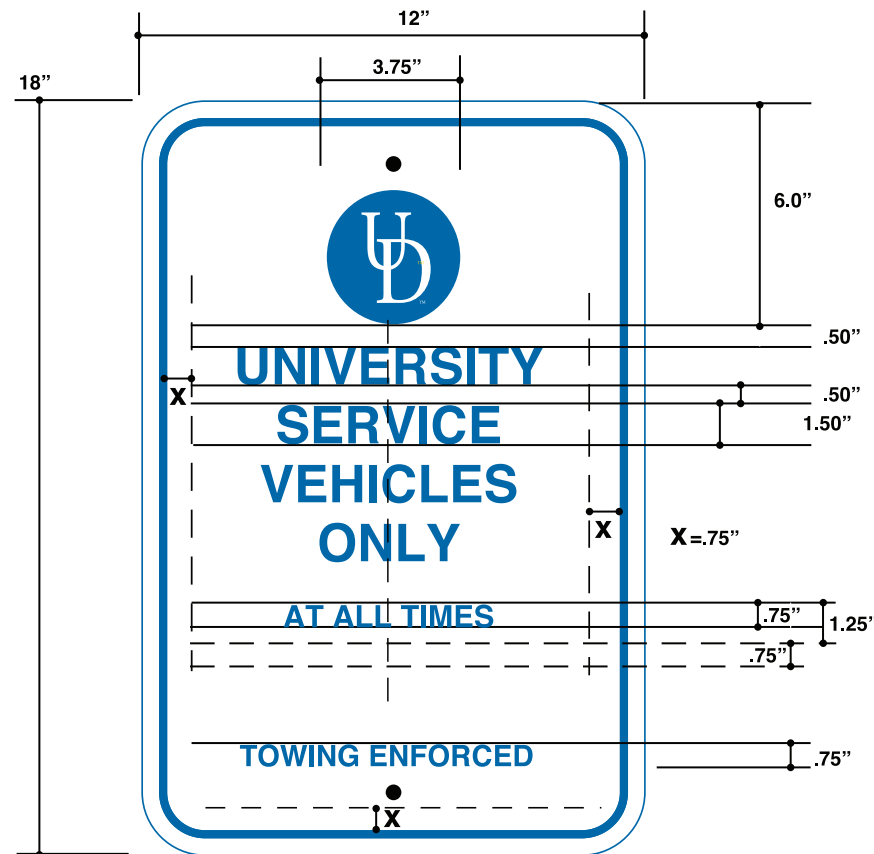

OPTION B:  
 < MONDAY – FRIDAY  
 7 A.M. – 5 P.M.

## 18" Reserved Space Sign

### Colors



White 3M 5100 (reflective)	Intense Blue (180C-47)	3M Controllac Plus Graphic Film
White	Pantone 2945C	Pantone Color Matching System
White	Blue	Acrylic Polyurethane

### Font

Helvetica Bold CAPS, no size distortion

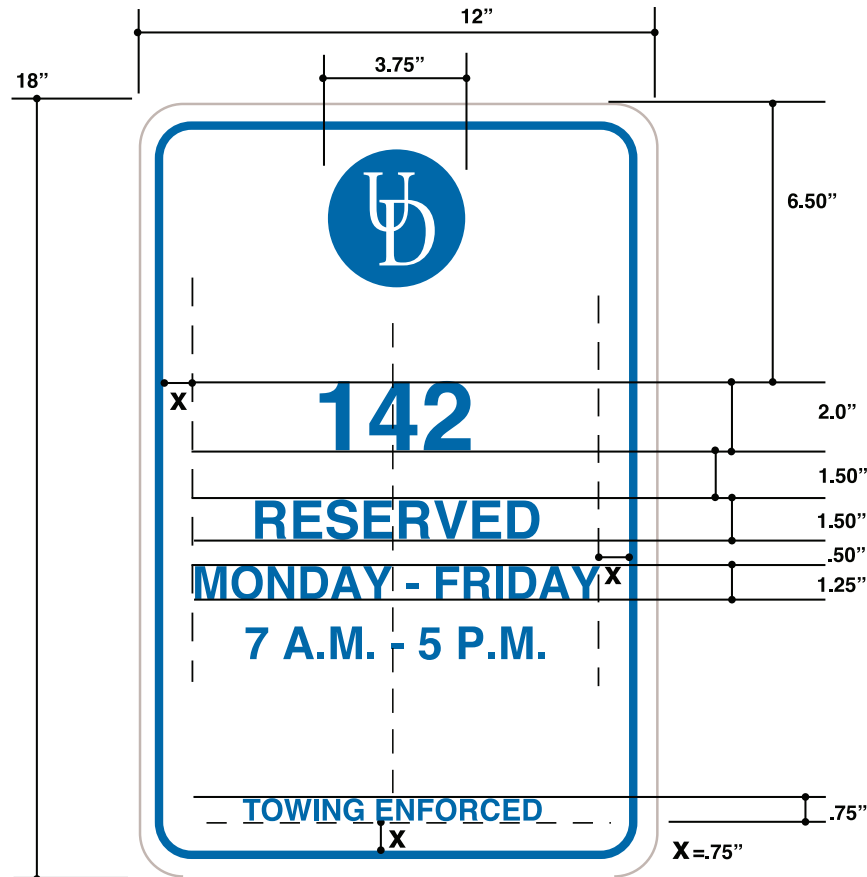

**OPTION B:**  
**< MONDAY - FRIDAY**  
**7 A.M. - 7 P.M.**

**OPTION C:**  
**AT ALL TIMES**

# 18" ADA Sign

## Colors



White (5000)

Blue 680-75, 680CR-75)

Scotchlite Reflective Graphic Film

Pantone 2945C

Pantone Color Matching System

White

Blue

Acrylic Polyurethane

## Font

Helvetica Bold CAPS, no size distortion

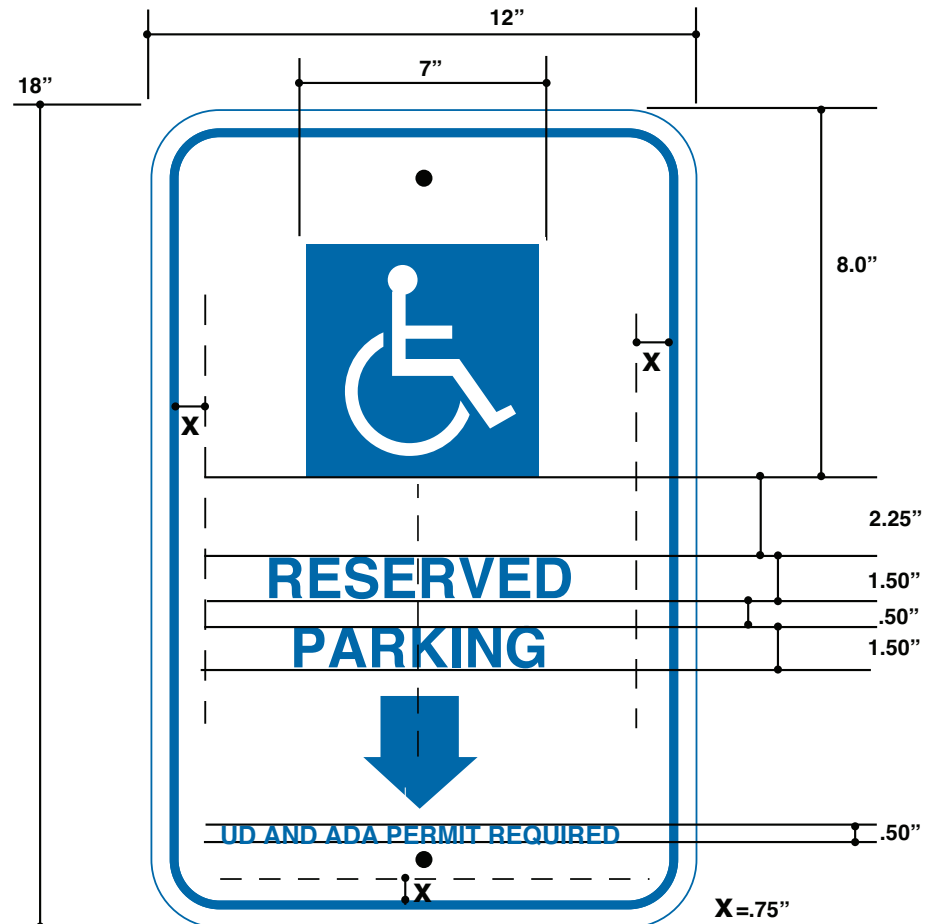



## 8" Motorcycle Sign

### Colors



White 3M 5100 (reflective)

Intense Blue (180C-47)

3M Controltac Plus Graphic Film

White

Pantone 2945C

Pantone Color Matching System

White

Blue

Acrylic Polyurethane

### Font

Helvetica Bold CAPS, no size distortion

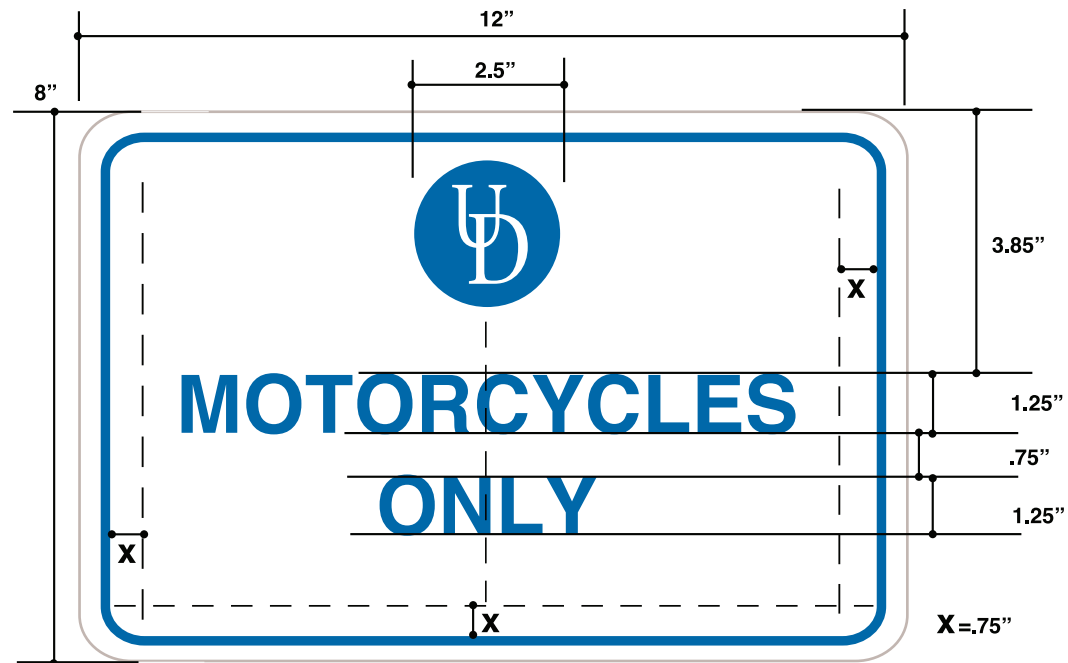

# 18" Pedestrian Walkway Sign

## Colors



White 3M 5100 (reflective)

Intense Blue (180C-47)

3M Controltac Plus Graphic Film

White

Pantone 2945C

Pantone Color Matching System

White

Blue

Acrylic Polyurethane

## Font

Helvetica Bold CAPS, no size distortion

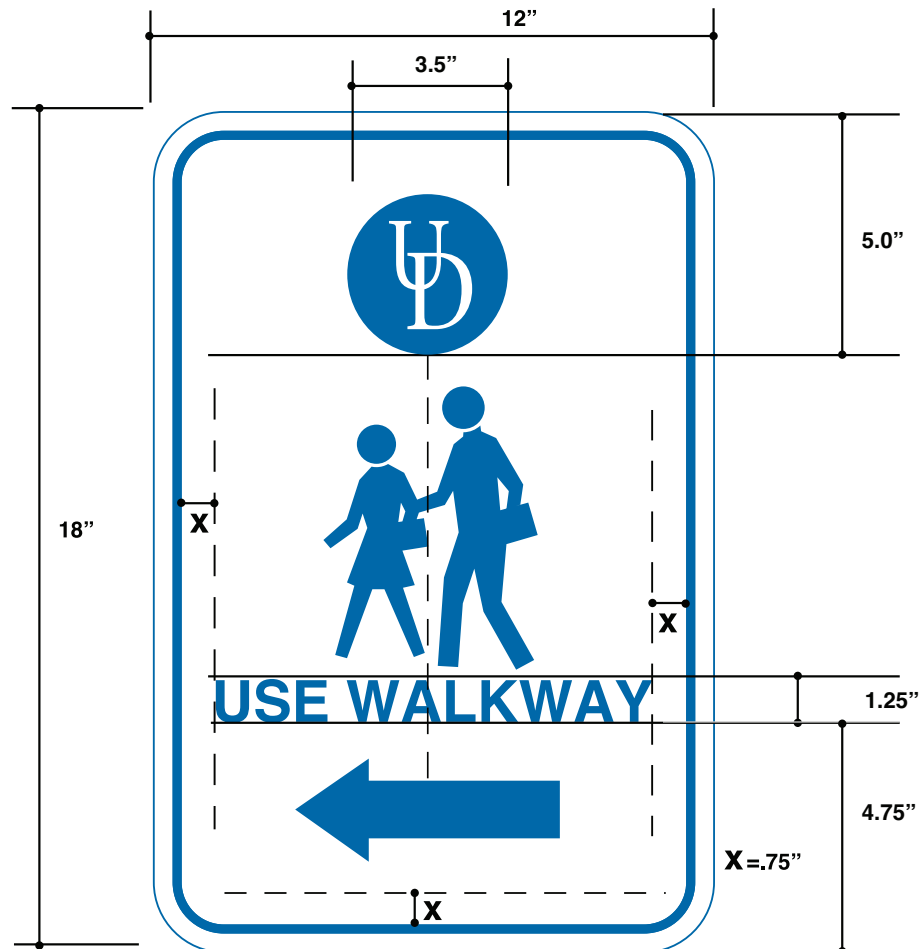

# 18" Shuttle Bus Stop Sign

## Colors



White 3M 5100 (reflective)	Intense Blue (180C-47)	3M Controltac Plus Graphic Film
White	Pantone 2945C	Pantone Color Matching System
White	Blue	Acrylic Polyurethane

## Font

Helvetica Bold CAPS, no size distortion

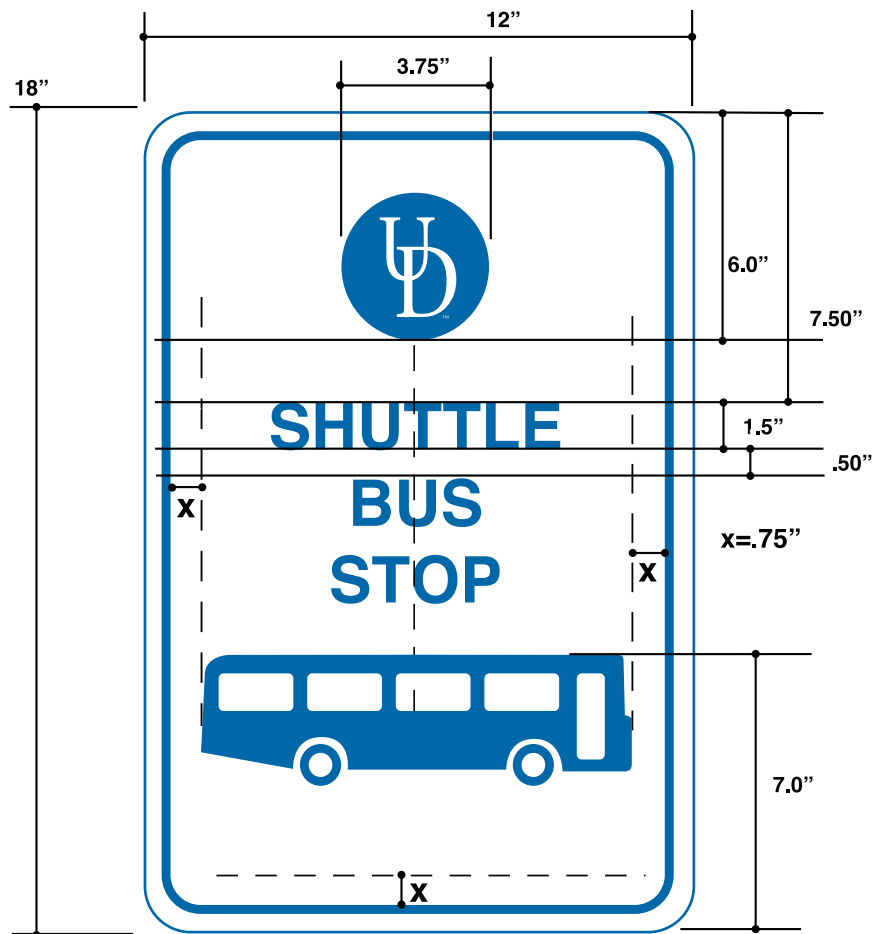

## 24" Reserved Football

### Colors



White (5000)

Green (680-56, 680CR-56)

Blue 680-75, 680CR-75)

Scotchlite Reflective Graphic Film

Pantone 342C

Pantone 2945C

Pantone Color Matching System

White

Green

Blue

Acrylic Polyurethane

**Font** Helvetica Bold CAPS, no size distortion



# 18" Low Emitting & Fuel Efficient Vehicles Sign

## Colors



White 3M 5100 (reflective)

Intense Blue (180C-47)

3M Controltac Plus Graphic Film

White

Pantone 2945C

Pantone Color Matching System

White

Blue

Acrylic Polyurethane

## Font

Helvetica Bold CAPS, no size distortion

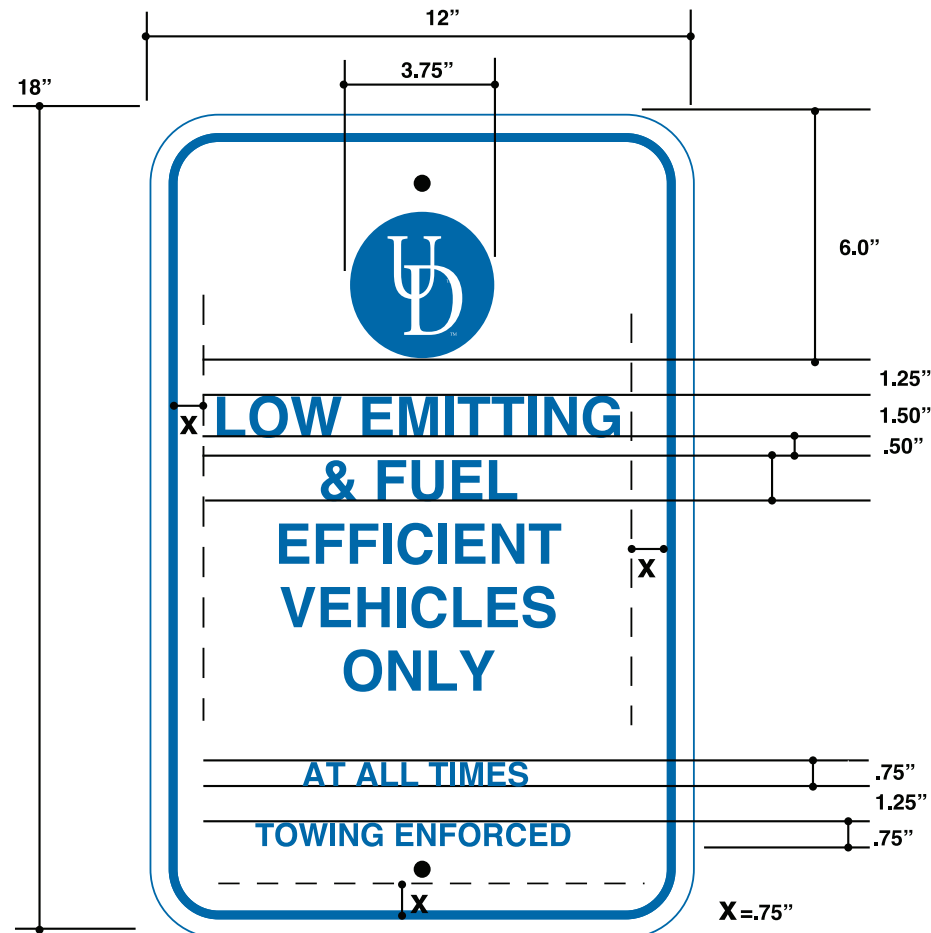

# 18" UD Electric Vehicle Sign

## Colors



White (5000)



Green (680-56, 680CR-56)



Blue 680-75, 680CR-75)

Scotchlite Reflective Graphic Film

Pantone 342C

Pantone 2945C

Pantone Color Matching System

White

Green

Blue

Acrylic Polyurethane

**Font** Helvetica Bold CAPS, no size distortion

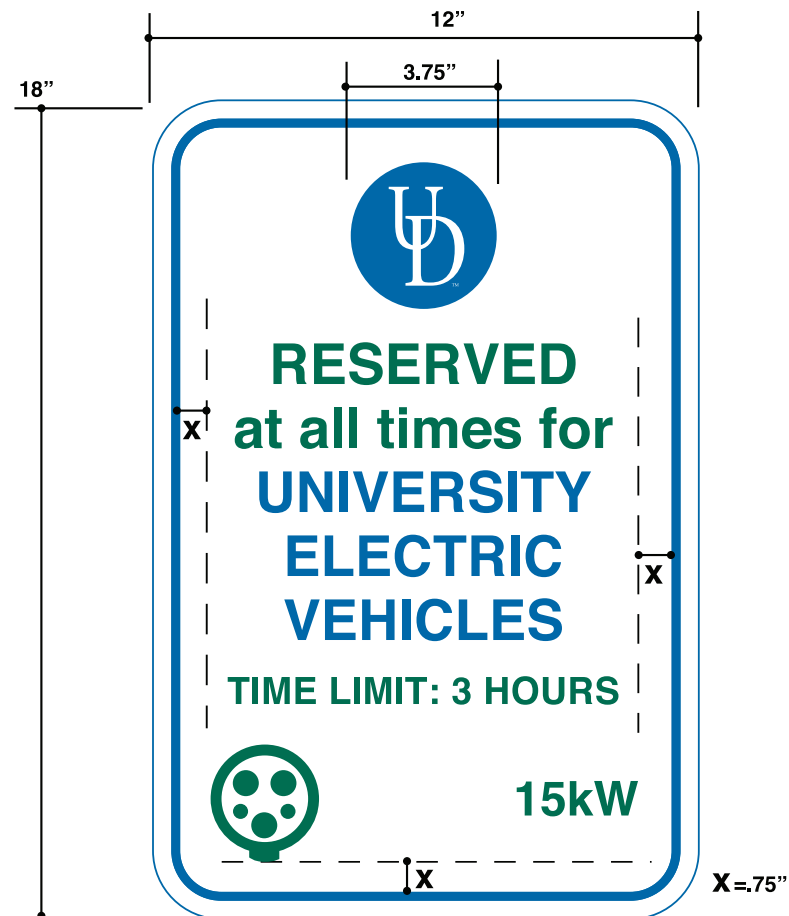

## 12" Tobacco-Free Campus Sign

### Colors



White (5000)



Blue 680-82



Blue 680-75, 680CR-75

Scotchlite Reflective Graphic Film

Pantone 199C

Pantone 2945C

Pantone Color Matching System

White

Red

Blue

Acrylic Polyurethane

### Font

Helvetica Bold CAPS, no size distortion

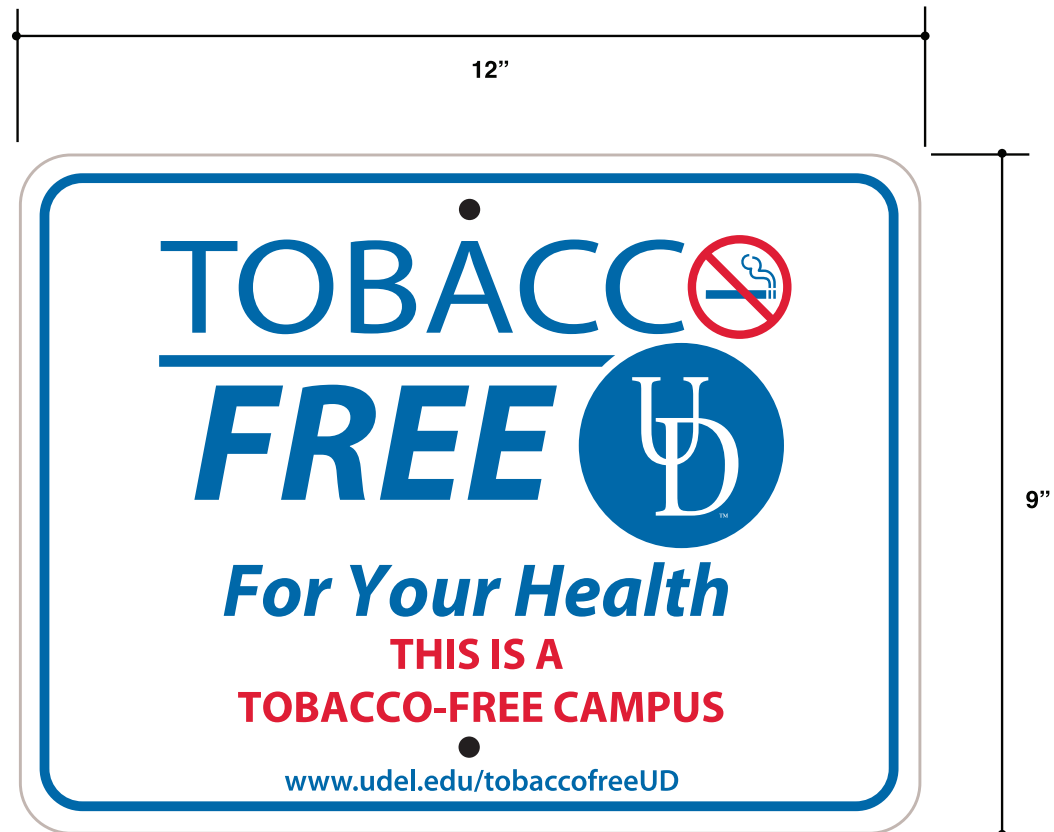

## 96" & 48" Parking Garage Signs

### Colors



White (5000)



Green (680-56, 680CR-56)



Blue 680-75, 680CR-75)

Scotchlite Reflective Graphic Film

Pantone 342C

Pantone 2945C

Pantone Color Matching System

White

Green

Blue

Acrylic Polyurethane

**Font** Helvetica Bold CAPS, no size distortion

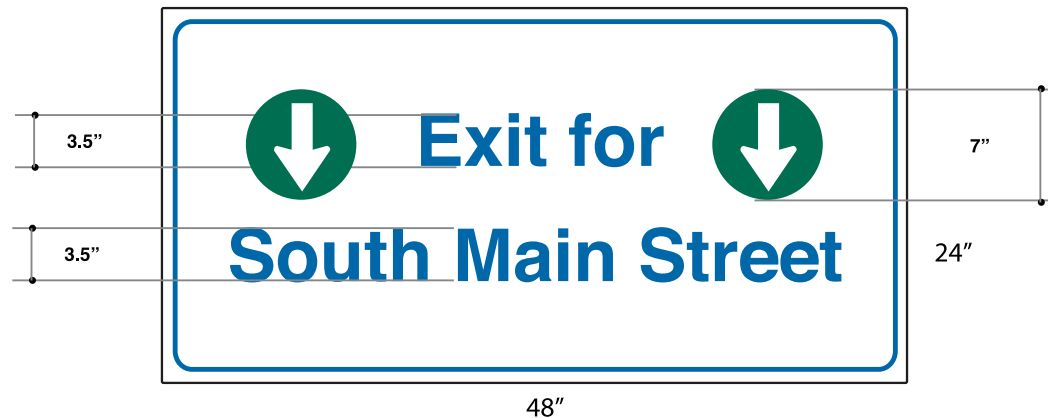
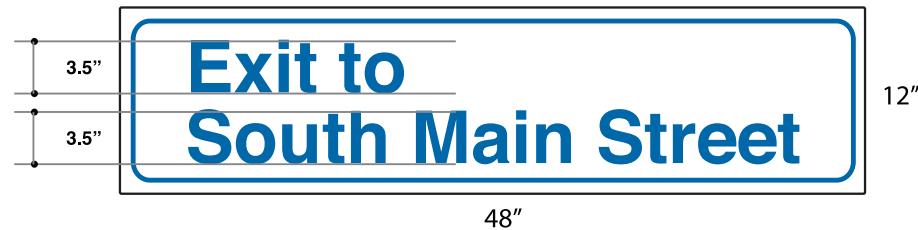



## 36" Fee Structure Sign

### Colors



White (5000)



Green (680-56, 680CR-56)



Blue 680-75, 680CR-75)

Scotchlite Reflective Graphic Film

Pantone 342C

Pantone 2945C

Pantone Color Matching System

White

Green

Blue

Acrylic Polyurethane

**Font** Helvetica Bold CAPS, no size distortion

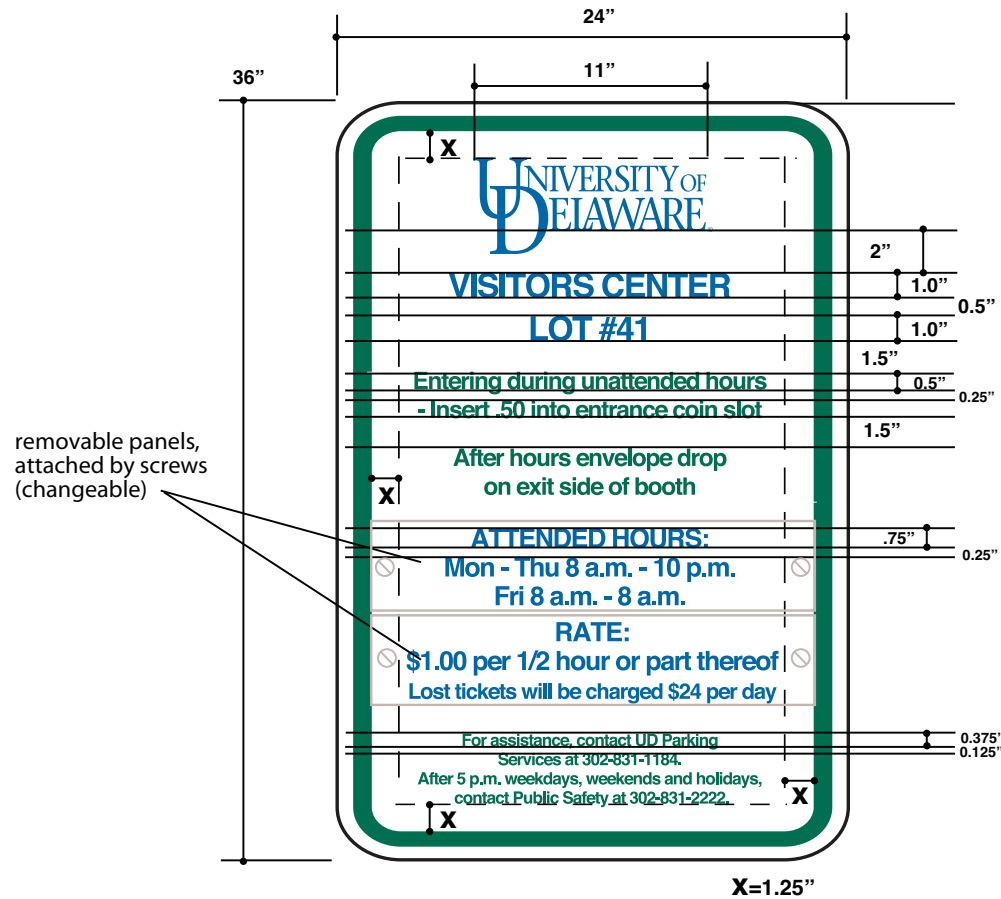

### OPTIONS

**PERKINS STUDENT CENTER-GARAGE LOT#4C**

**TRABANT UNIV. CENTER GARAGE LOT#17C**

**CENTER FOR THE ARTS GARAGE LOT#14C**

# 18" UD Garage Assistance Sign

## Colors



White (5000)



Green (680-56, 680CR-56)



Blue 680-75, 680CR-75

Scotchlite Reflective Graphic Film

Pantone 342C

Pantone 2945C

Pantone Color Matching System

White

Green

Blue

Acrylic Polyurethane

**Font** Helvetica Bold CAPS, no size distortion

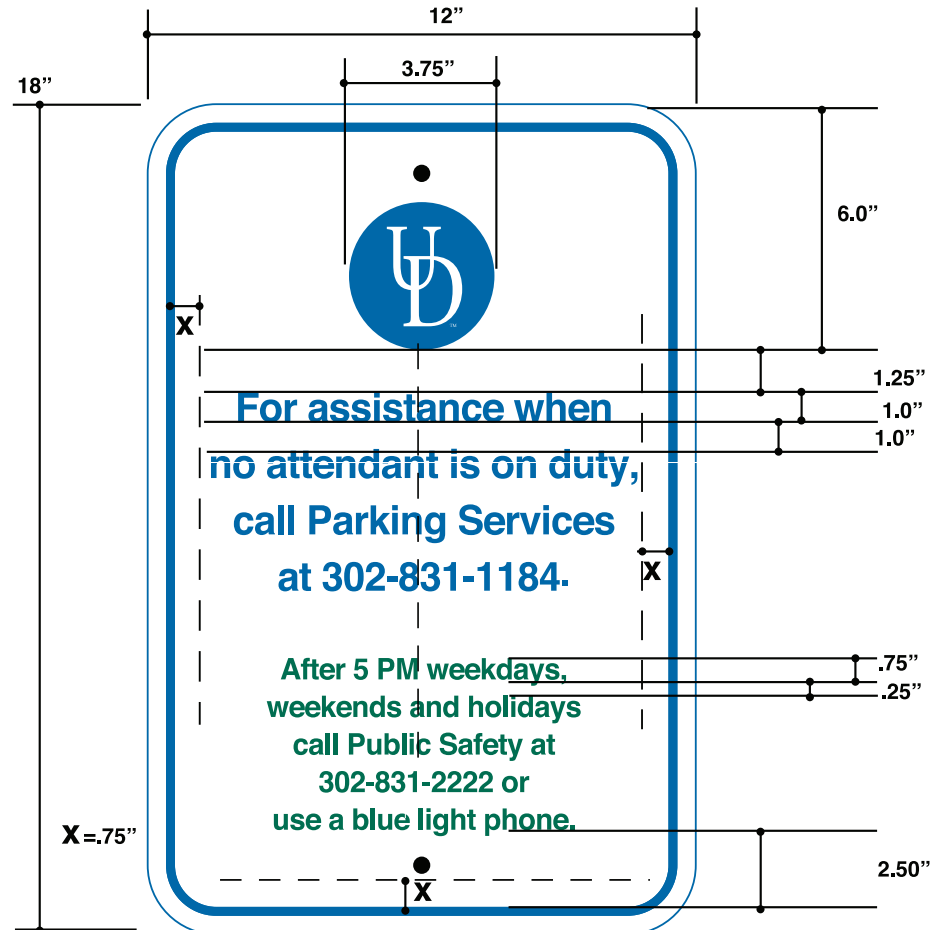

## UD Security Monitoring Signs

### Colors



White (5000)



Blue 680-75, 680CR-75

Scotchlite Reflective Graphic Film

Pantone 2945C

Pantone Color Matching System

White

Blue

Acrylic Polyurethane

**Font** Helvetica Bold CAPS, no size distortion

12" x 18"



12" x 12" and 18" x 18"

alternate version



### Examples of University Signage

#### A. Building Identification/Address Signs, Surface-mounted

Material: Aluminum (see size variations and details on previous pages)

Font: Myriad Pro Bold, Myriad Pro Semibold

Dimensions: 7" x 8", 8.5" x 10", 12" x 14.5", 20" x 24"

Notes: Primary logo with Building/Department Identification

#### B. Building Card Reader Signs, Surface-mounted

Material: PVC

Logo: white Circle UD

Dimensions: 8" x 8"

#### C. Building Identification Signs, Surface-mounted

Material: Cast bronze (see photos)

Font: Stone Serif Medium

Dimensions: 19" x 15"

Notes: UD Circle logo with Building/Department Identification and address

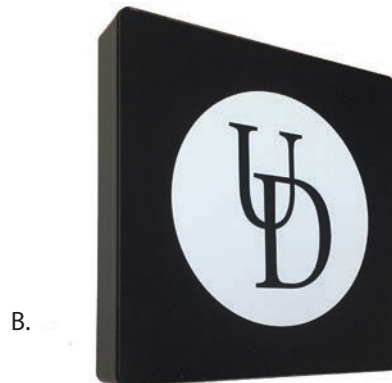

## UD SIGNAGE

### Examples of University Signage

#### D. Plaques

Material: Bronze

Font: Garamond Premiere Pro, Semibold

Size: Varies

Notes: Dedication/Historic Building/Donor Plaque

#### E. Building History Sign, Freestanding Plaque

Material: Bronze, cement, brick

Font: Garamond Premiere Pro

Name: Semibold 60 pt.

Body text: Semibold 36 pt.

Size:

Brick Base: 32" wide x 25.5" deep x 16" high

Top of Base (white cement): 24" wide x 18.5" deep

Plaque: 18" wide x 12" high

1/4" border, single line

Background color: Dark Oxide

Material: Bronze

Background texture: Stipple

Total height: approx. 28"

Notes: Dedication/History Plaque

#### E-1. Variation

Can also have commemorative plaque on front face brick base.

(Must be approved)

Bronze Plaque: 9" wide x 6" high



E-1.



D.



E.

## UD SIGNAGE

### **Building Naming Pin Lettering**

#### **A. Building Identification**

Material: metal (preferably black, bronze or brushed steel/aluminum/nickel)

Dimensions: 7-10" height

Font/Typeface: Stone Serif Regular/Medium

Kerning: approx. +35

All final heights and kerning will be determined and approved by UD.



## UD SIGNAGE

### UD Walkway Gates

Material: metal, painted black

Logo: modified version of Circle UD logo/mark (please obtain correct vector logo art from Office of Communications and Marketing).

Final approval of gate mockup must be approved by OCM for consistency and correct use of logo/mark..

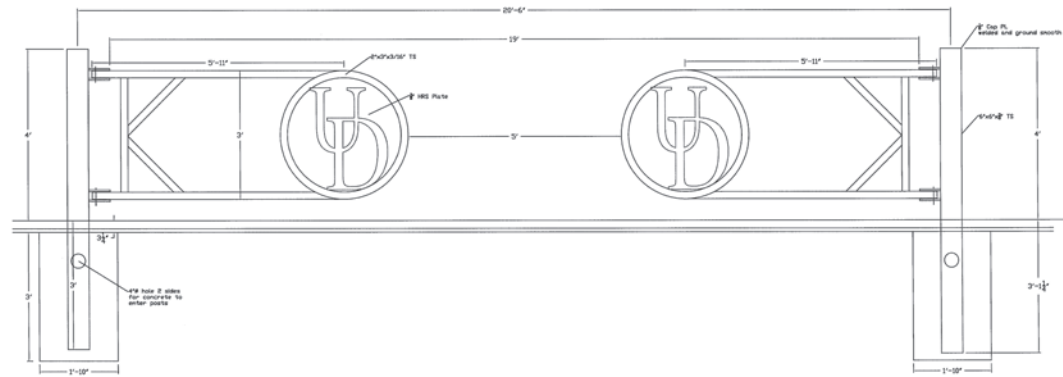
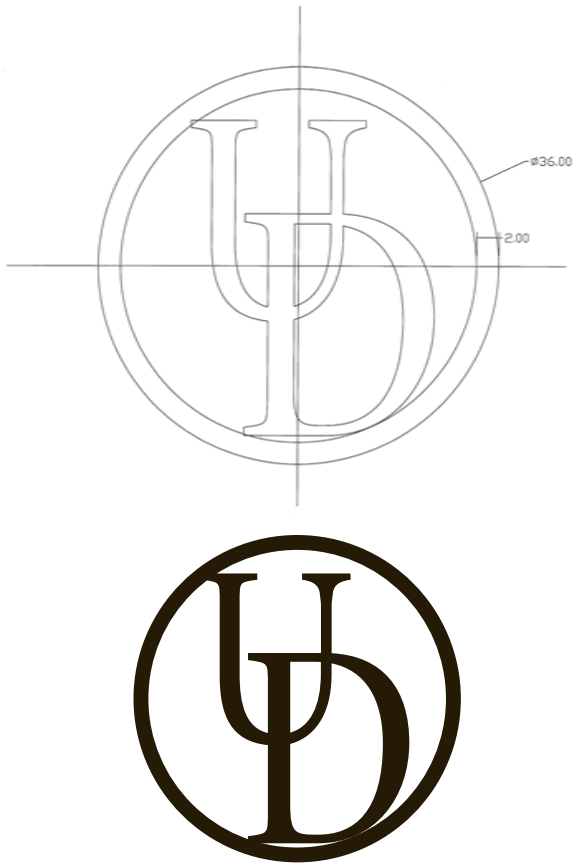

**Construction Sign 4' x 6' Variation**



**Construction Sign 4' x 6' Variation with Funding Attachment**



**Typical Architect Rendering Construction Sign 4' x 8'**

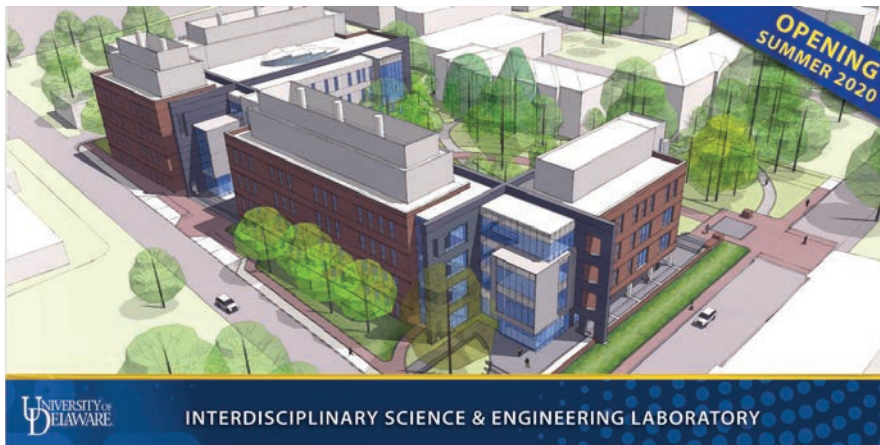

**Architect Rendering Construction Sign Variation 4' x 8'**





## Typical Construction Title Sign 4' x 8'



## Construction Title Sign 4' x 8' Variations

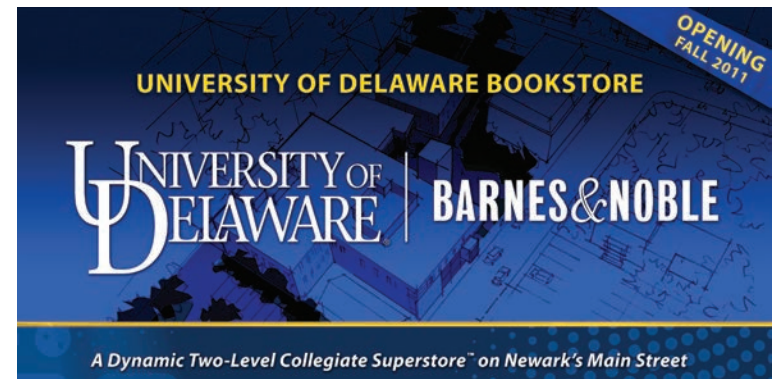

## Sample Pedestrian Detour Map Sign 4' x 8'

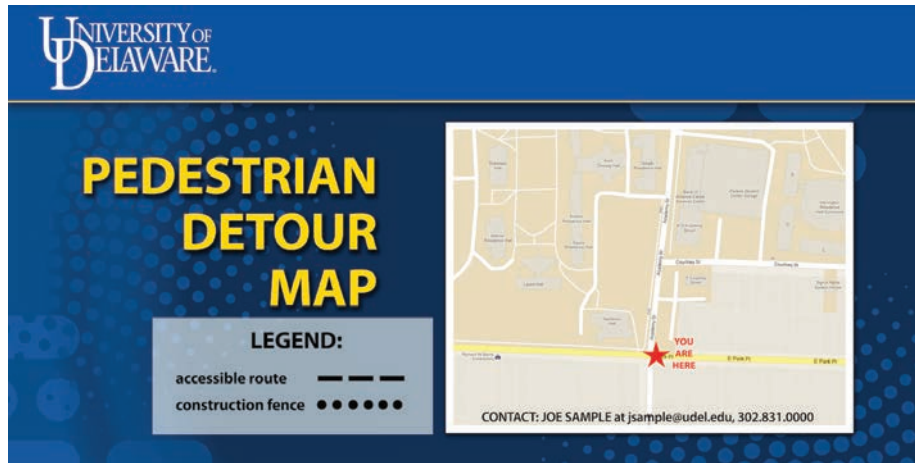

## Construction Fence Wind Screen Signage





## Vehicle Brand Style Guide

## UD VEHICLES

### UD Campus Vehicles

The following illustrations and guidelines identify the proper use, placement and color of the University's logo on campus vehicles.

For questions about vehicular signage with respect to layout, colors and/or use of the UD logo, or to obtain a high-resolution electronic file, please contact the Office of Communications and Marketing at 302- 831-2791.

### Logo color, vinyl color chart





Color	selected vinyl manufacturers		
	Avery	3M Opaque	3M Reflective
(UD Blue) MOTOR POOL ONLY	-Impulse Blue A6587-0 A6 opaque (6 year) or -Vivid Blue A9570-0 A9 opaque (9 yr)	-Vivid Blue 180C-17 opaque	

Any questions concerning the layout of UD logos or to obtain a hi-resolution electronic file, please contact OCM 302- 831-2791.

**Motor Pool Vehicles**

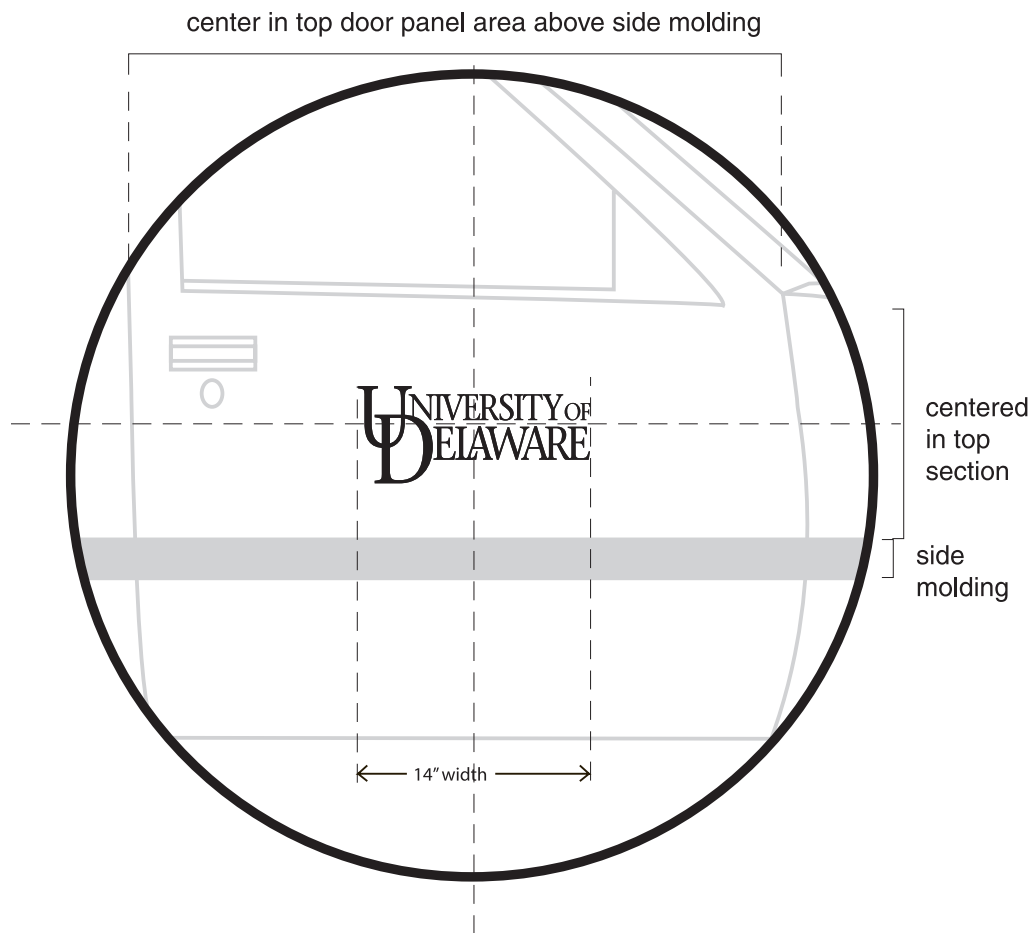
Guidelines for placement of UD logo and identity



Identity Legend	
<p><b>Use official art files only</b></p> <ul style="list-style-type: none"> <li>-14" wide x 5.9" h (smaller) logo</li> <li>- UD Primary Logo – (Blue) PMS 2945c</li> <li>see vinyl color chart</li> <li>Do NOT attempt to recreate!</li> </ul>	
<ul style="list-style-type: none"> <li>-2 inch identity number</li> <li>-PMS 2945c – Blue</li> <li>-Stone serif Semibold Italic font</li> </ul>	<p><i>123</i></p>

Any questions concerning the layout of UD logos or to obtain a hi-resolution electronic file, please contact OCM 302- 831-2791.

**Service Vehicles**

Guidelines for placement of UD logo and identity

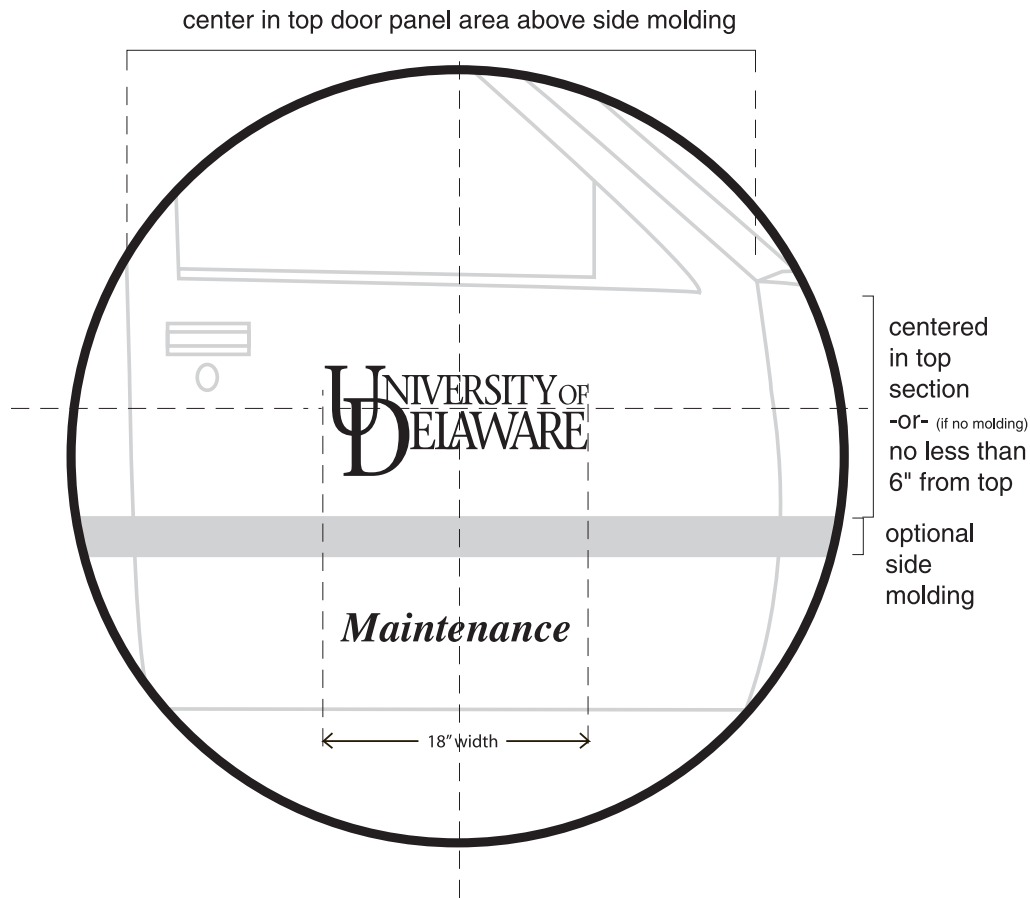

Identity Legend	
<p><b>Use official art files only</b></p> <ul style="list-style-type: none"> <li>-18" wide x 5.9" h (larger) logo</li> <li>- <b>UD Primary Logo</b> – (Blue) PMS 2945c Reflective* see vinyl color chart</li> </ul> <p>Do NOT attempt to recreate!</p>	
<ul style="list-style-type: none"> <li>-2 inch identity number</li> <li>-PMS 2945c – Blue Reflective*</li> <li>-Stone serif Semibold Italic font</li> </ul>	<p><i>123</i></p>

Any questions concerning the layout of UD logos or to obtain a hi-resolution electronic file, please contact OCM 302- 831-2791.

**Motor Pool and Service Vehicles**

Guidelines for placement of UD logo and identity number for vehicles other than car.

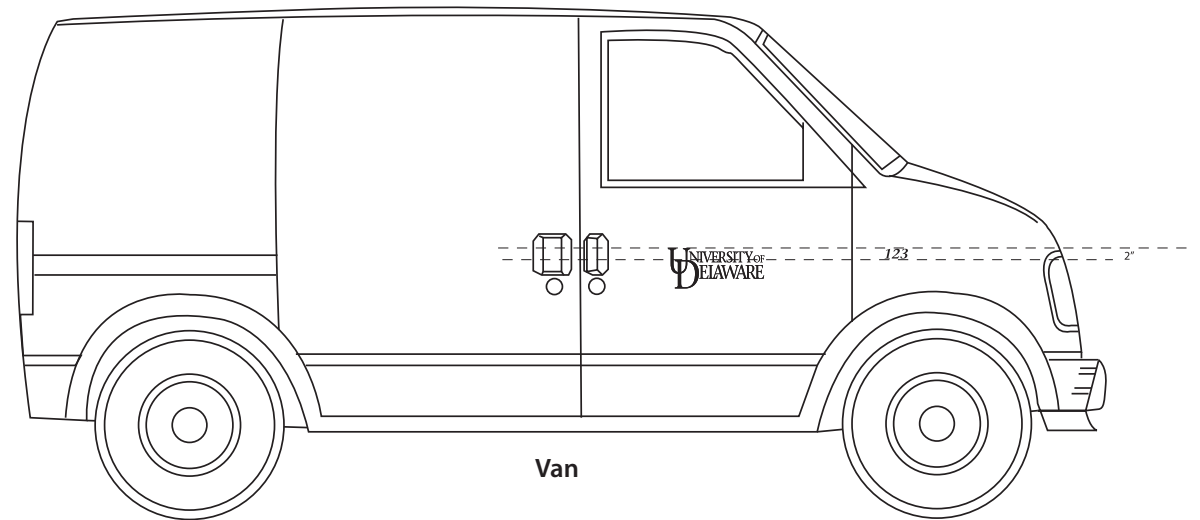
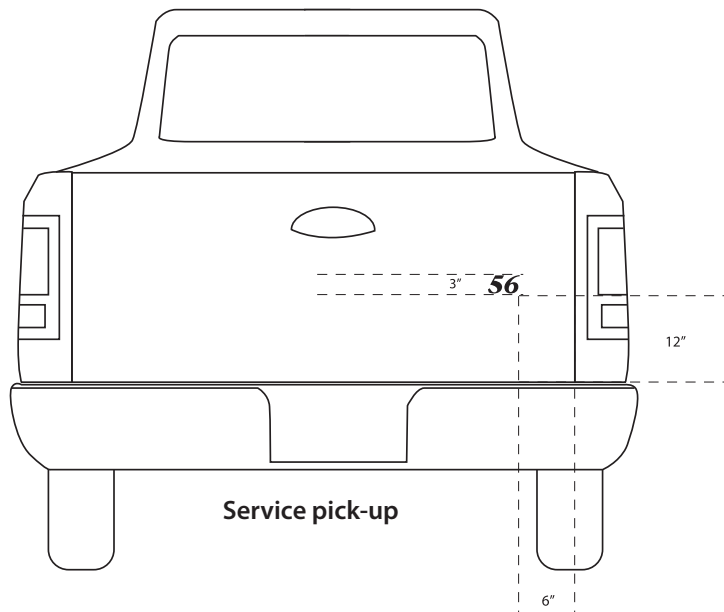

UD SHUTTLE BUSES





