

Low Energy Electron Diffraction - LEED

Presentation prepared by Professor Wolfgang Ranke
Dep. Inorganic Chemistry
Group Model Surface Analysis
Fritz-Haber-Institut der MPG

Literature:

G. Ertl, J. Küppers, Low Energy Electrons and Surface Chemistry, VCH, Weinheim (1985).
M. Henzler, W. Göpel, Oberflächenphysik des Festkörpers, Teubner, Stuttgart (1991).
M.A. Van Hove, W.H. Weinberg, C.-M. Chan, Low-Energy Electron Diffraction, Experiment, Theory and Surface Structure Determination, Springer Series in Surface Sciences 6, G. Ertl, R. Gomer eds., Springer, Berlin (1986).
M. Horn-von Hoegen, Zeitschrift für Kristallographie 214 (1999) 1-75.
Low Energy Electron Diffraction - LEED

1. Introduction, General

Surface science, UHV, $p \sim 10^{-10}$ mbar

De Broglie wavelength: $\lambda = h/(mv)$

For electrons: $\lambda = \sqrt{150 / E_0}$ E_0 in eV, λ in Å.

For 100 eV-electrons: $\lambda(100) = 1.22$ Å (low energy)

corresponds to atomic dimensions, similar to XRD

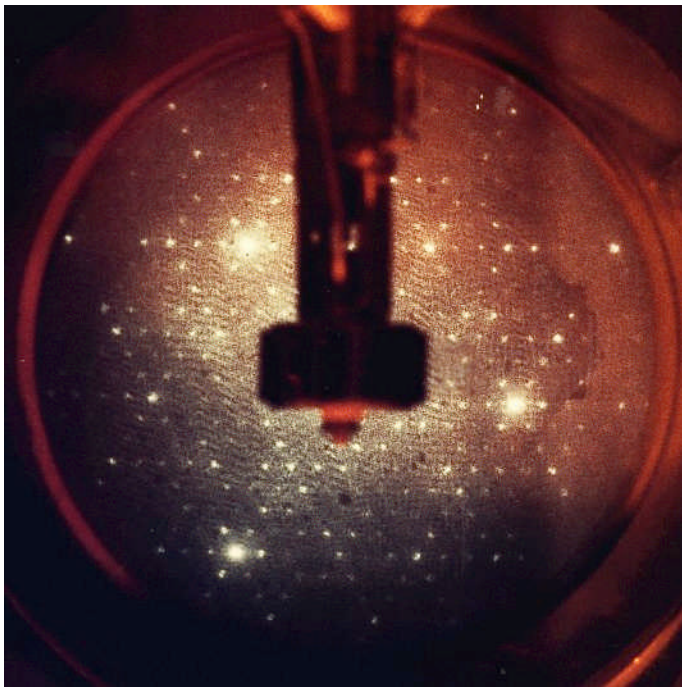

Si(111)-(7x7)

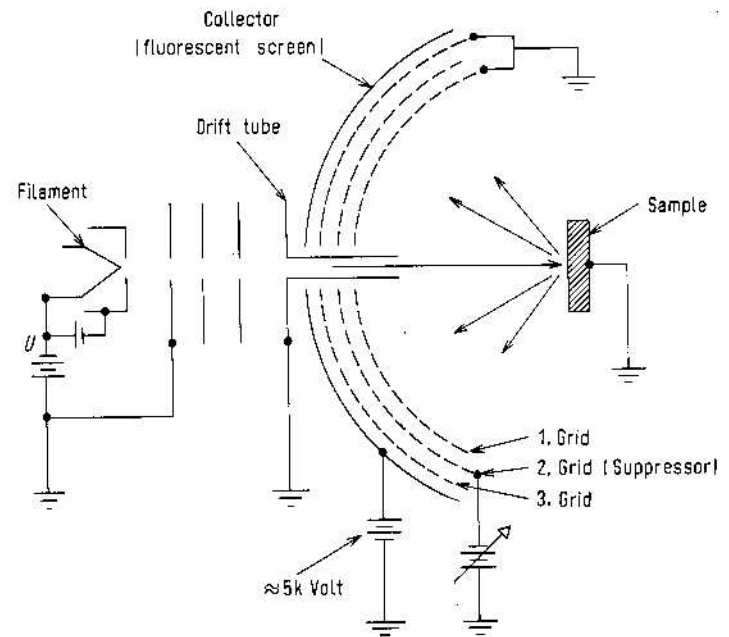

LEED display system

Ertl/Küppers fig. 9.7, p. 210

LEED is surface sensitive

Low energy electrons
interact strongly with matter:

electron mean free path λ_e

is small.

Only e^- scattered from near surface
can leave the surface,

surface sensitive

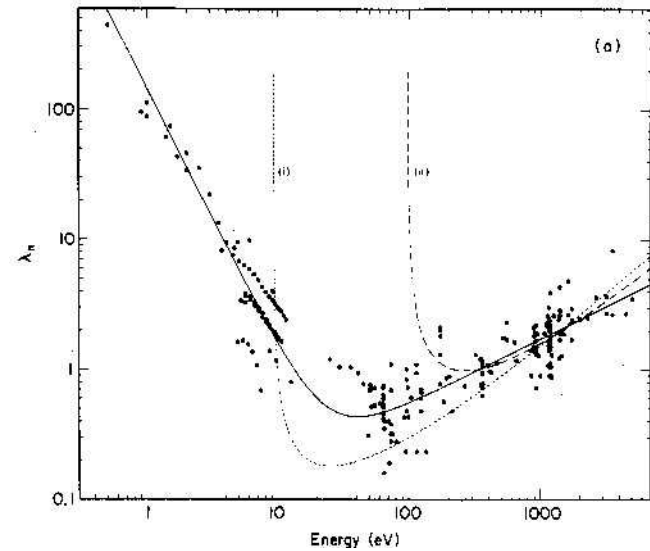

M.P. Seah, W.A. Dench, Surf. Interf. Anal. 1 (1979) 2

The observation of a LEED pattern
does not guarantee that the whole surface is ordered!

Coherence of e^- -beam limited by ΔE and beam divergence.
Coherence length = diameter of coherently scattering area.

The coherence length
of a standard LEED optics
is only 10 – 20 nm!

**1st approximation:
Scattering from 2-D lattice.**

Analogy to optical grating.

Constructive interference:
Enhancement of intensity only
in certain directions:

$$n \lambda = d \sin \varphi$$

For 2D arrangement (plane lattice):
scattering conditions have to be
fulfilled in both directions

Note:

If the lattice constant(s) a_1 (a_2) increase,
the scattering angle for the beam h (k)
decreases.

This is the reason for the reciprocity of the
real and the s.c. reciprocal lattice.

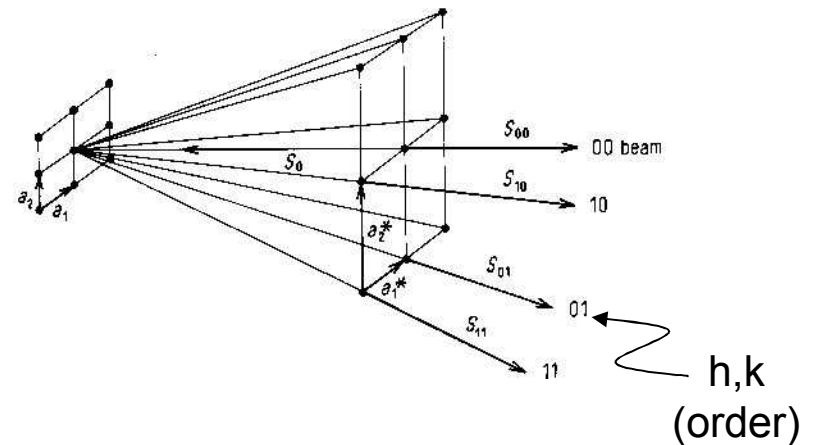
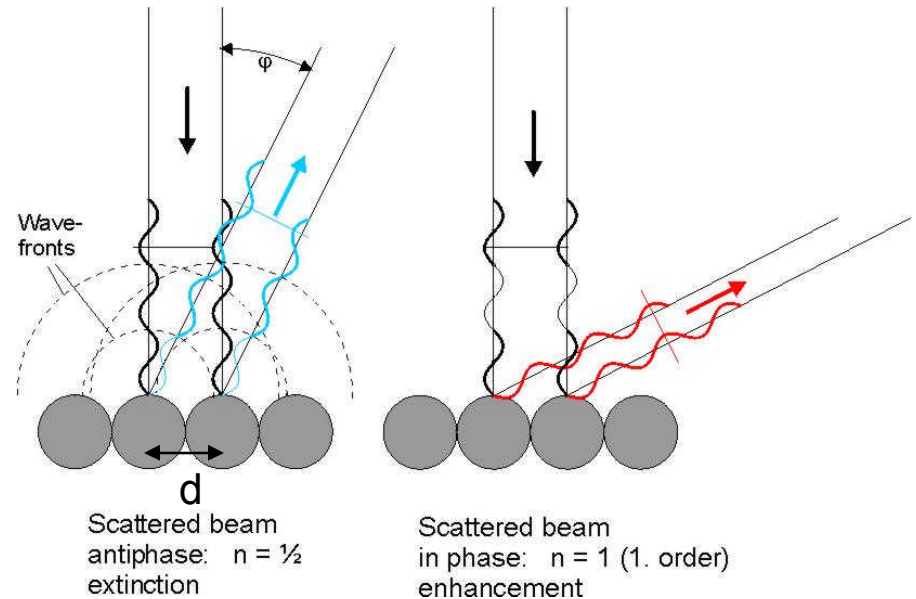

Formation of diffraction pattern

Useful: Introduction of reciprocal lattice

Real lattice vectors $\mathbf{a}_1, \mathbf{a}_2$
 Reciprocal lattice vectors $\mathbf{a}_1^*, \mathbf{a}_2^*$

Definitions: \mathbf{a}_1^* perpendicular to \mathbf{a}_2
 \mathbf{a}_2^* perpendicular to \mathbf{a}_1

$a_1^* = 1/(a_1 \sin \gamma)$
 $a_2^* = 1/(a_2 \sin \gamma)$
 γ angle between \mathbf{a}_1 and \mathbf{a}_2

Constructive interference for:

$$\mathbf{a}_1 (\mathbf{s} - \mathbf{s}_0) = h \lambda$$

$$\mathbf{a}_2 (\mathbf{s} - \mathbf{s}_0) = k \lambda$$

(Laue conditions for 2 dimensions)

Real 2D system: 3rd Laue condition always fulfilled.

It follows for the direction of beams:

$$1/\lambda (\mathbf{s} - \mathbf{s}_0) = 1/\lambda \Delta \mathbf{s} = h \mathbf{a}_1^* + k \mathbf{a}_2^* = \mathbf{g}$$

\mathbf{g} = reciprocal lattice vector

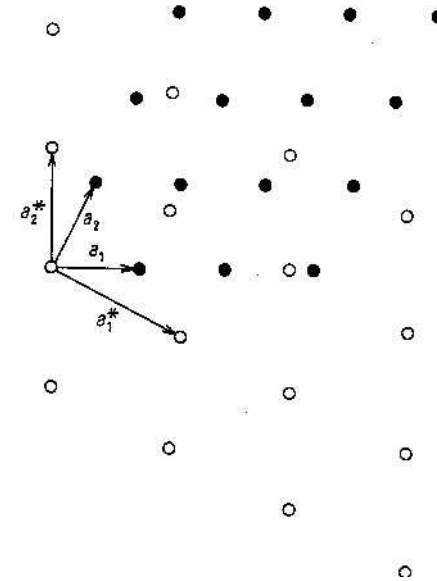

Example

Ertl/Küppers fig. 9.11, p 216

Ewald sphere construction

- plot reciprocal lattice (rods)
- plot direction of incident beam (\mathbf{s}_0) towards (00) spot
- go $1/\lambda$ along this direction
- make circle (sphere) with radius $1/\lambda$
- direction from circle (sphere) center towards cut with reciprocal lattice rods gives direction of all possible diffraction spots (hk)

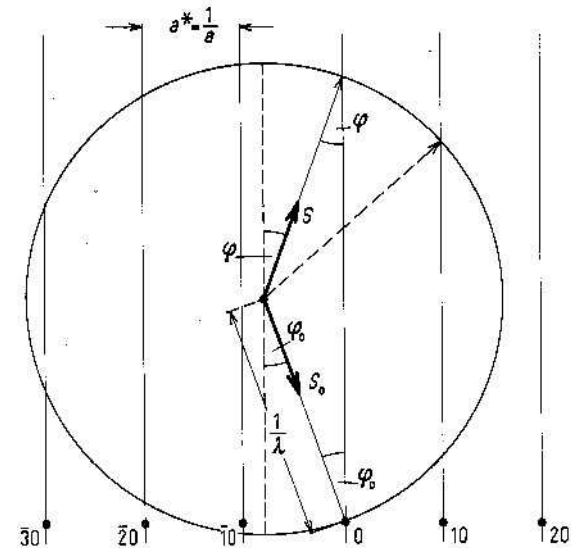

Ertl/Küppers fig. 9.13, p. 218

Usual arrangement:

Normal incidence,
symmetrical diffraction pattern

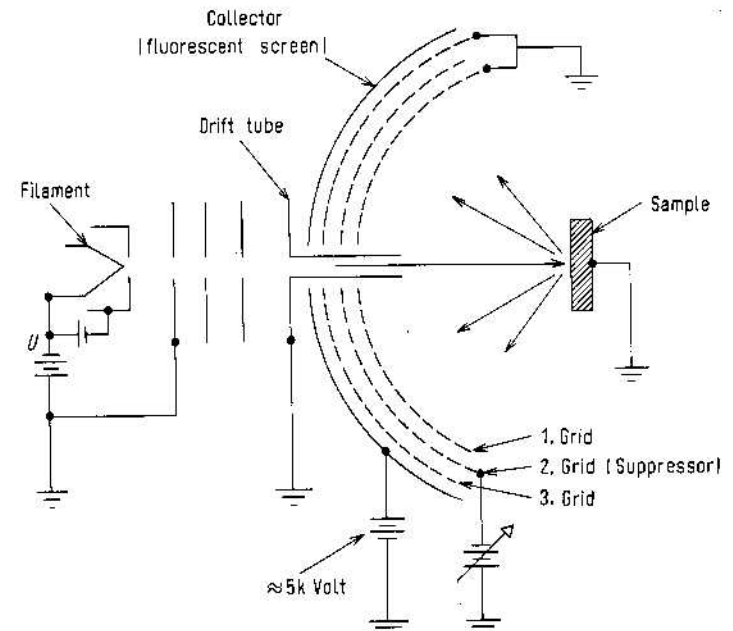

Ertl/Küppers fig. 9.7, p. 210

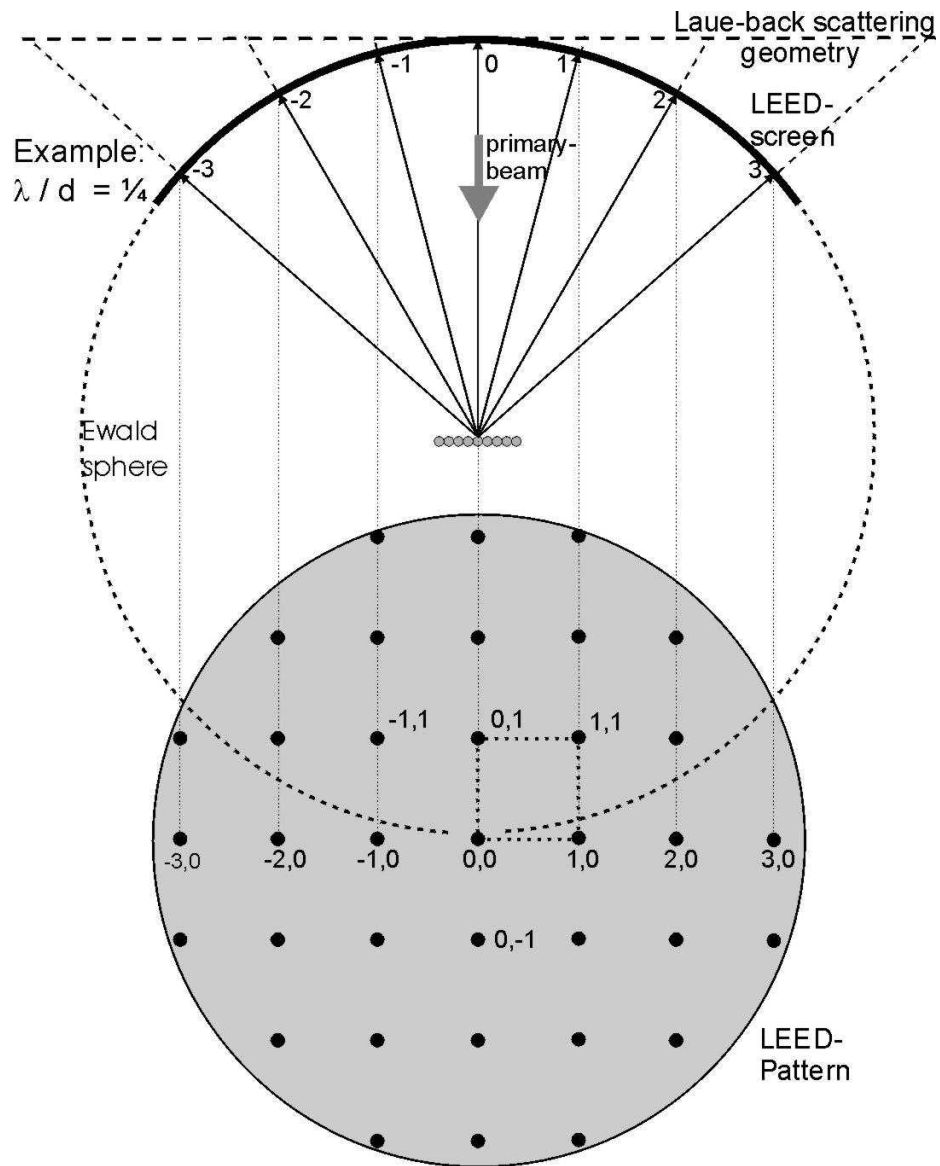

Expected diffraction pattern for (001) surface,
 e.g. Pt(001) (unreconstructed), $E_0=313$ eV

(a) **x-rays**

weak interaction
single scattering
kinematic theory

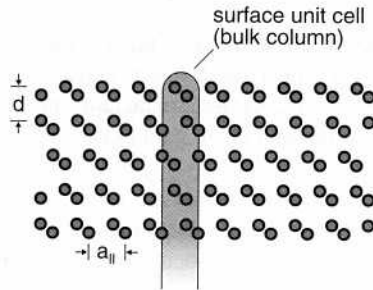

(b) **He atoms**

strong repulsion
single scattering
kinematic theory

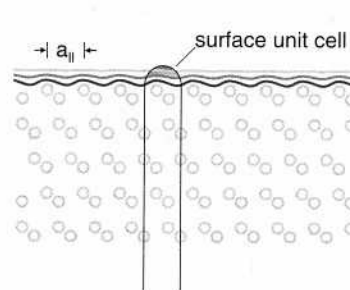

(c) **electrons**

strong interaction
multi scattering
dynamic theory

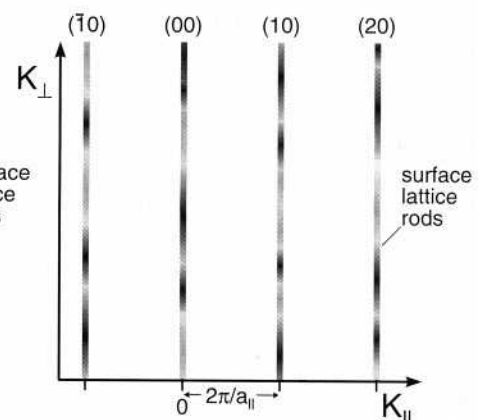
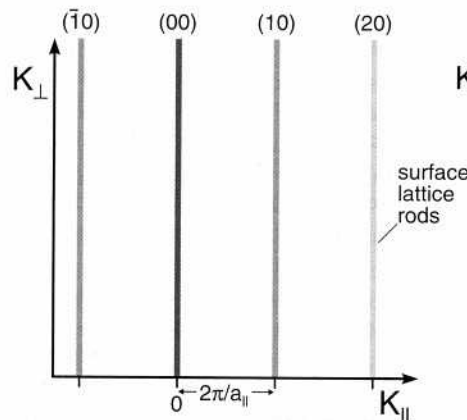
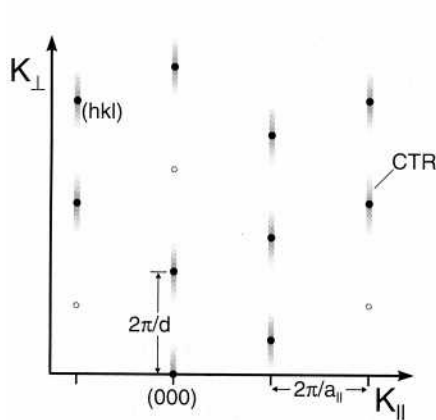
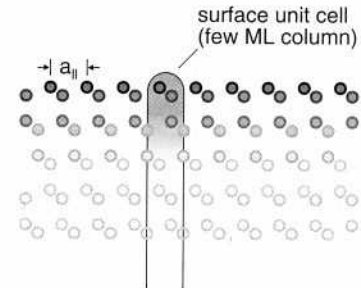

Surface diffraction with X-rays, He-atoms and electrons.

Example: diamond-type (111) surface like C, Si, Ge.

The darkness of rec. latt. spots and rods symbolizes diffraction intensity

Horn-von Hoegen, fig. 2.1

LEED:

2. Simple

Kinematic theory (single scattering)
Size, shape and symmetry of surface unit cell,
Superstructures
Domains
only if long-range ordered

No information about atomic arrangement within the unit cell

3. Less simple

Kinematic theory
Deviations from long-range order:
Spot width → domain size
Background intensity → point defect concentration
Spot splitting → atomic steps

4. Difficult

Dynamic theory (multiple scattering)
Spot intensities $I(E_0)$ or I-V curves → structure within unit cell

2. LEED – simple

Superstructures result from:

Reconstruction = rearrangement of surface atoms on clean surfaces

Ordered adsorption

Structure examples

Overlayer structures

Ertl/Küppers fig. 9.2, p.204

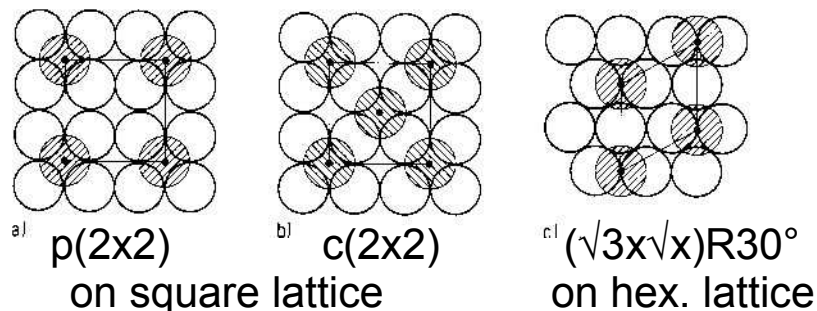

Superstructure nomenclature

Wood: Simplest in most cases
 p or $c(n \times m)R\vartheta^\circ$
 unit cell vector lengths
 $b_1 = n a_1$ $b_2 = m a_2$
 rotation ϑ p =primitive, c =centered

Matrix notation (Park and Madden)
 more general

m_{11}	m_{12}	$\mathbf{b}_1 = m_{11} \mathbf{a}_1 + m_{12} \mathbf{a}_2$
m_{12}	m_{22}	$\mathbf{b}_2 = m_{12} \mathbf{a}_1 + m_{22} \mathbf{a}_2$

Wood	(2×2) [$\vartheta=0$ is omitted]	$(\sqrt{3} \times \sqrt{3})R30^\circ$
Matrix	$\begin{matrix} 2 & 0 \\ 0 & 2 \end{matrix}$	$\begin{matrix} 1 & 1 \\ 2 & -1 \end{matrix}$

Three possible arrangements yielding $c(2 \times 2)$ structures.
 Note: different symmetry!

Ertl/Küppers fig. 9.6, p.208

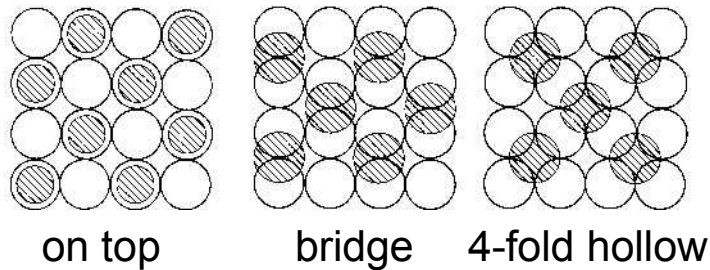

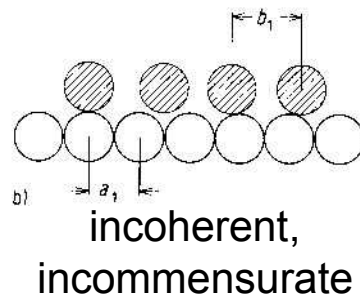
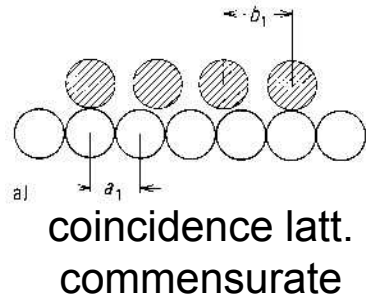

Ertl/Küppers fig. 9.3, p.205

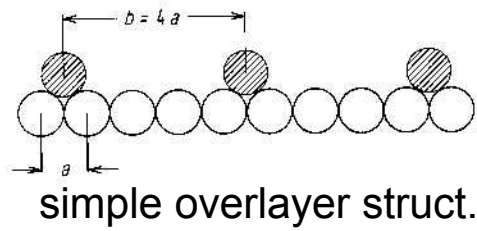
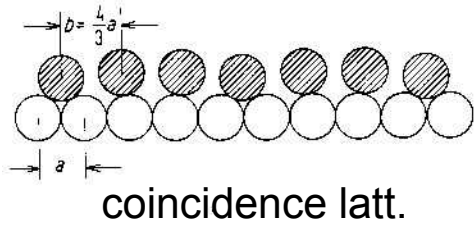

Ertl/Küppers fig. 9.19, p.224

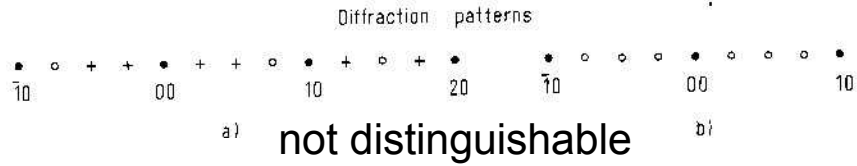

Real and reciprocal space lattices

Van Hove et al. fig. 3.5, p.55

REAL SPACE LATTICE	RECIPROCAL LATTICE
	$\begin{cases} \text{fcc (100)} - \begin{pmatrix} 1 & 0 \\ 0 & 1 \end{pmatrix} \\ \text{fcc (100)} - (1 \times 1) \end{cases}$
	$\begin{cases} \text{fcc (100)} - \begin{pmatrix} 2 & 0 \\ 0 & 1 \end{pmatrix} \\ \text{fcc (100)} - (2 \times 1) \end{cases}$
	$\begin{cases} \text{fcc (100)} - \begin{pmatrix} 2 & 0 \\ 0 & 2 \end{pmatrix} \\ \text{fcc (100)} - (2 \times 2) \end{cases}$
	$\begin{cases} \text{fcc (100)} - \begin{pmatrix} 1 & 1 \\ -1 & 1 \end{pmatrix} \\ \text{fcc (100)} - (\sqrt{2} \times \sqrt{2}) R45^\circ \\ \text{fcc (100)} - c(2 \times 2) \end{cases}$
	$\begin{cases} \text{fcc (110)} - \begin{pmatrix} 1 & 0 \\ 0 & 1 \end{pmatrix} \\ \text{fcc (110)} - (1 \times 1) \end{cases}$
	$\begin{cases} \text{fcc (110)} - \begin{pmatrix} 2 & 0 \\ 0 & 1 \end{pmatrix} \\ \text{fcc (110)} - (2 \times 1) \end{cases}$
	$\begin{cases} \text{fcc (110)} - \begin{pmatrix} 1 & 0 \\ 0 & 2 \end{pmatrix} \\ \text{fcc (110)} - (1 \times 2) \end{cases}$
	$\begin{cases} \text{fcc (111)} - \begin{pmatrix} 1 & 0 \\ 0 & 1 \end{pmatrix} \\ \text{fcc (111)} - (1 \times 1) \end{cases}$
	$\begin{cases} \text{fcc (111)} - \begin{pmatrix} 1 & 1 \\ 2 & -1 \end{pmatrix} \\ \text{fcc (111)} - (\sqrt{3} \times \sqrt{3}) R30^\circ \end{cases}$
	$\begin{cases} \text{fcc (111)} - \begin{pmatrix} 2 & 0 \\ 0 & 2 \end{pmatrix} \\ \text{fcc (111)} - (2 \times 2) \end{cases}$
	$\begin{cases} \text{fcc (111)} - \begin{pmatrix} 1 & 0 \\ 0 & 2 \end{pmatrix} \\ \text{fcc (111)} - (1 \times 2) \end{cases}$

Superstructures, example 1

GaAs(001)
clean,
different preparations

As(31)/Ga(55)
Auger peak height ratios:

c(8x2)	1.74
(4x6)	1.77
c(6x4)	1.92
(1x6)	2.12
c(2x8)	2.25
c(4x4)	2.7

Information from patterns:

- symmetry of unit cell
- size and shape of surface unit cell
- sharpness of spots
→ domain size
- background intensity
→ concentration of point defects

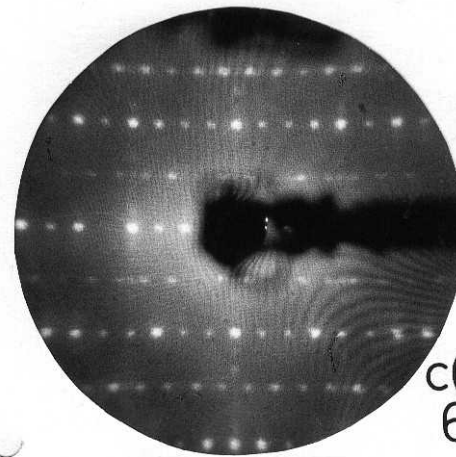

c(8x2)
66eV

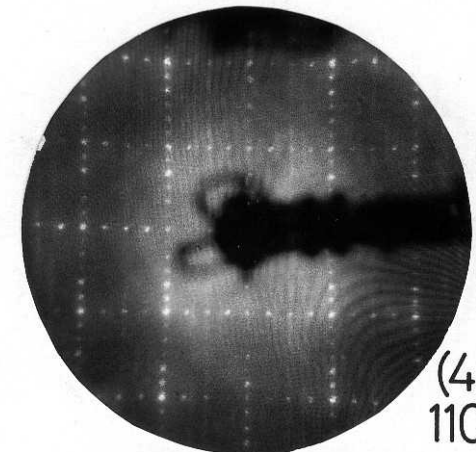

(4x6)
110eV



c(6x4)
36eV

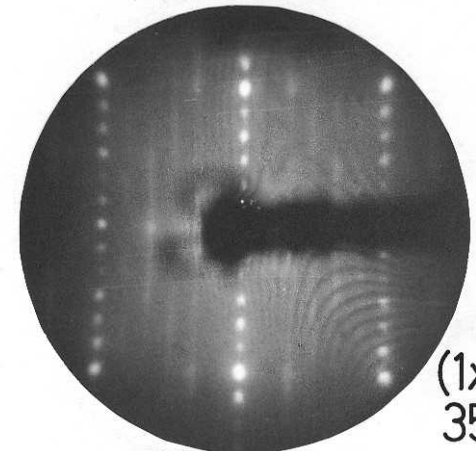

(1x6)
35eV

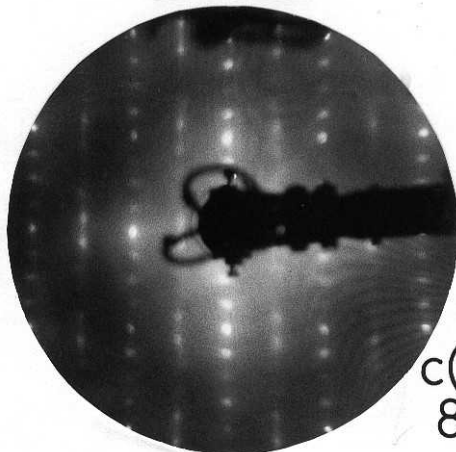

c(2x8)
80eV

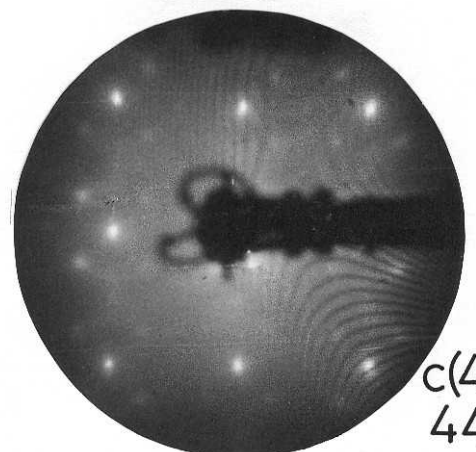

c(4x4)
44eV

Superstructures, example 2

Si(001) clean

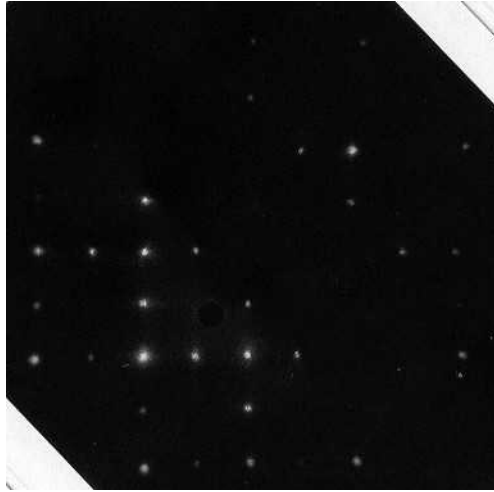

no 2x2 structure!
central spots missing
→ two-domain 2x1

Wasserfall, Ranke, 1994

C, Si, Ge (001)

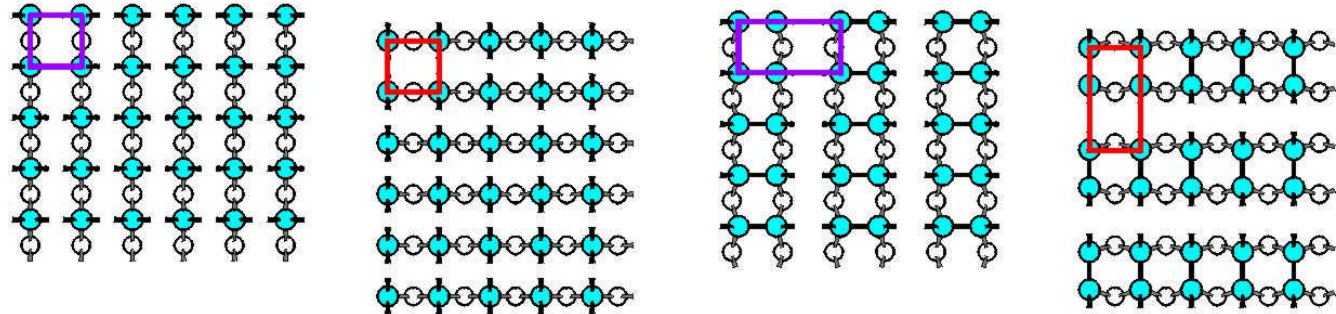

(1x1)

(2x1) and (1x2)

no 4-fold rotation symmetry!

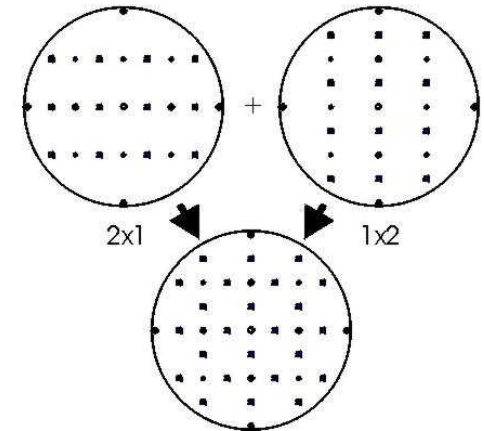
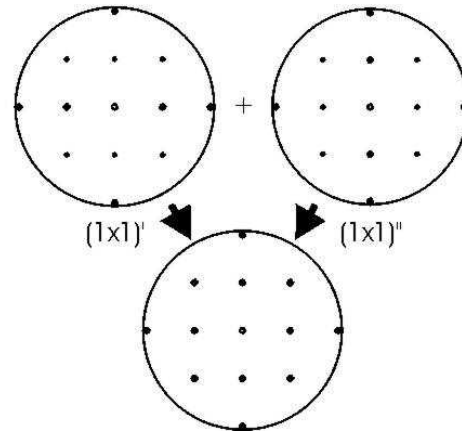

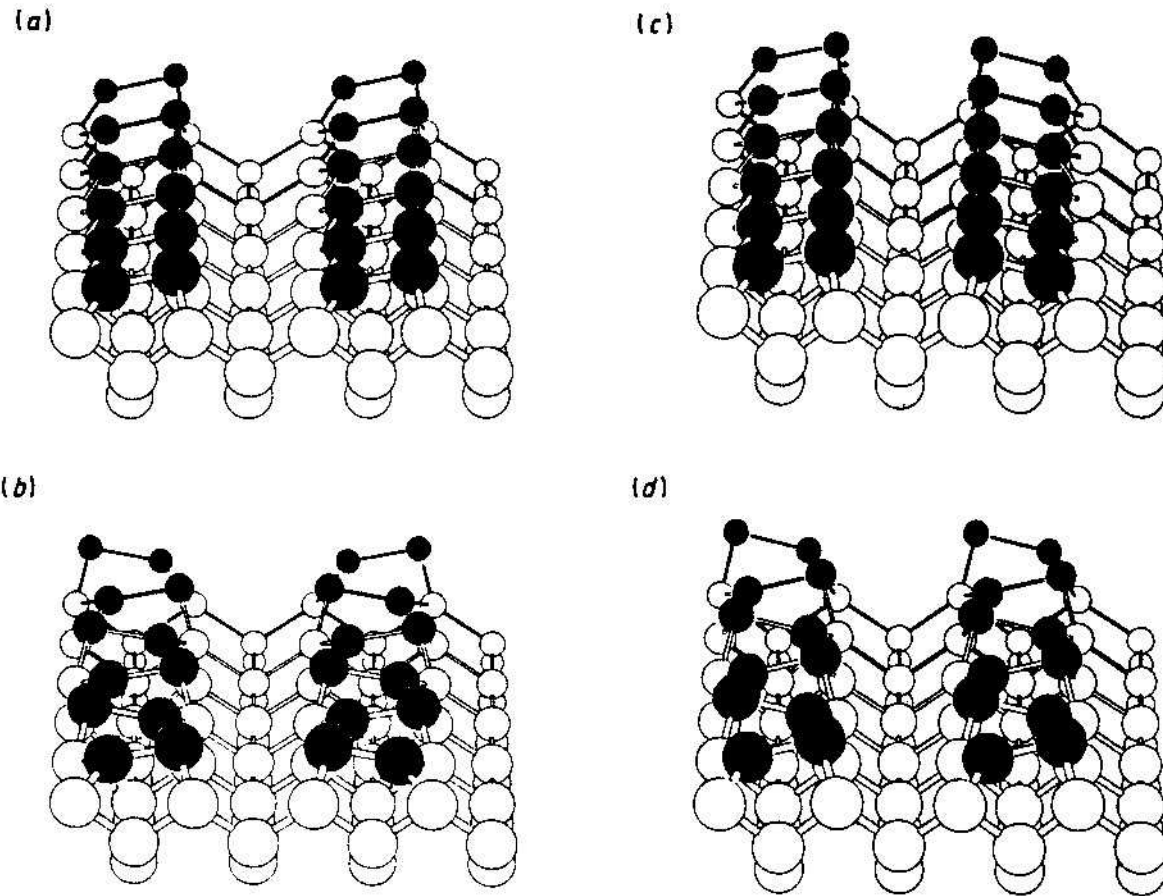







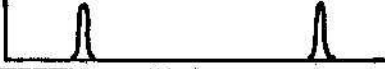

Figure 3. Buckled dimer reconstructions on the (001) surface of germanium: (a) $b(2 \times 1)$; (b) $c(4 \times 2)$; (c) $p(4 \times 1)$; (d) $p(2 \times 2)$.

3. LEED – less simple

Information from spot shape (profile), background, E_0 -dependence (k_{\perp} -dependence)

Nachweis von Oberflächendefekten mit Beugung				
Dimen- sion	Beispiele An	Einfluß auf Reflexprofil		
0	Punktfehler thermische Bewegung statische Unordnung	Anordnung: statistisch		K_{\perp} Abhängigkeit keine
		korreliert		
1	Stufenkanten Domänen (Größe, Grenzen)	statistisch		periodisch (Stufen)
		regelmäßig		
2	Überstruktur Facetten			keine
				periodisch
3	Volumendefekte (Mosaik, Verspannung)			monoton
ideale Oberflächen				keine

Facets and mosaic

Henzler, Göpel
Abb. 3.8.4, p.167

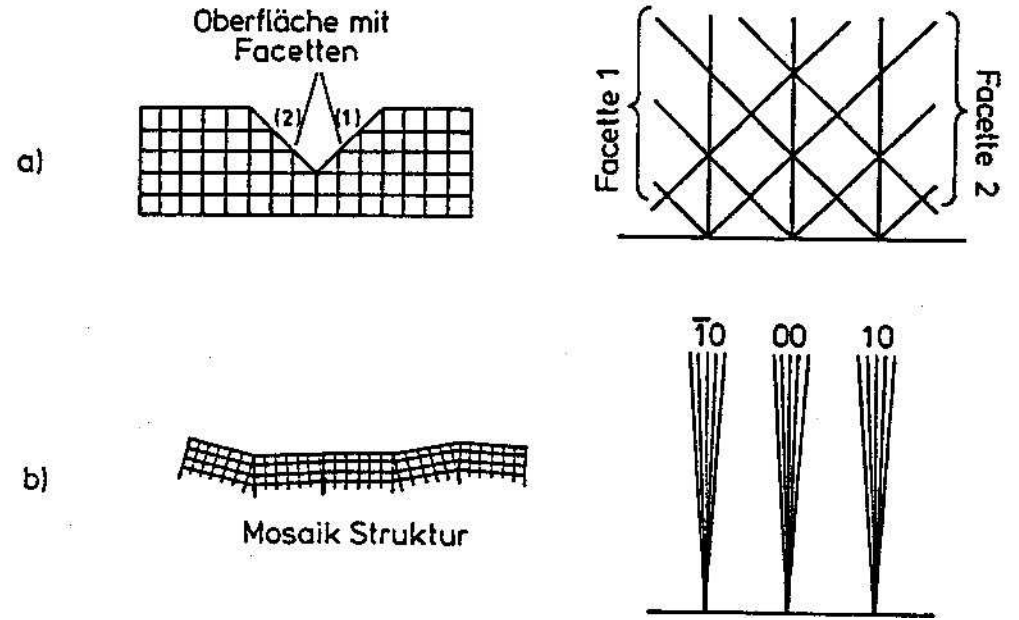

Regular atomic steps

Van Hove et al., fig. 3.6, p.58

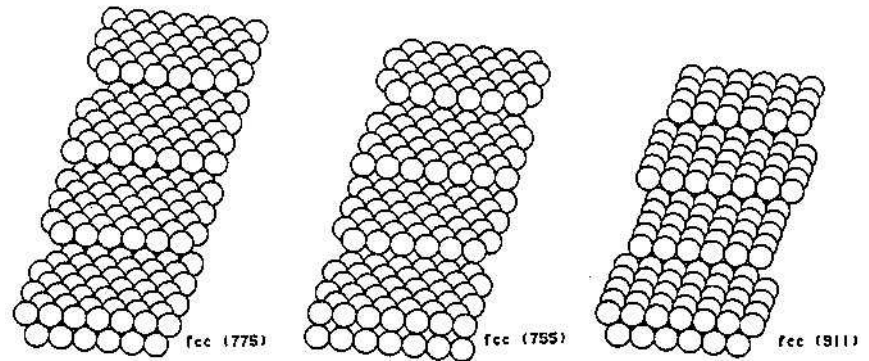

Anordnung (Ortsraum)

a) Ideale Oberfläche

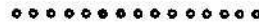

b) Einzelterrasse $I_E(K_a)$



c) Stufenfolge $I_F(K_g)$

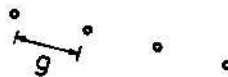

d) gestufte Oberfläche $I_E \cdot I_F$

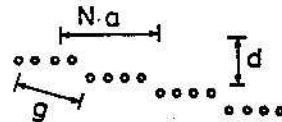

Reziproker Raum

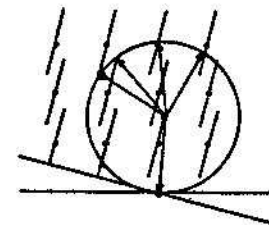
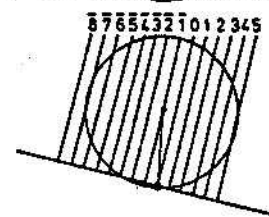
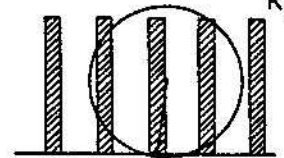
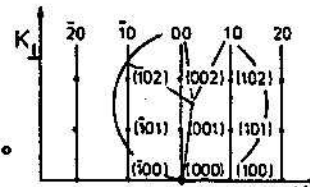

Beugungsbild

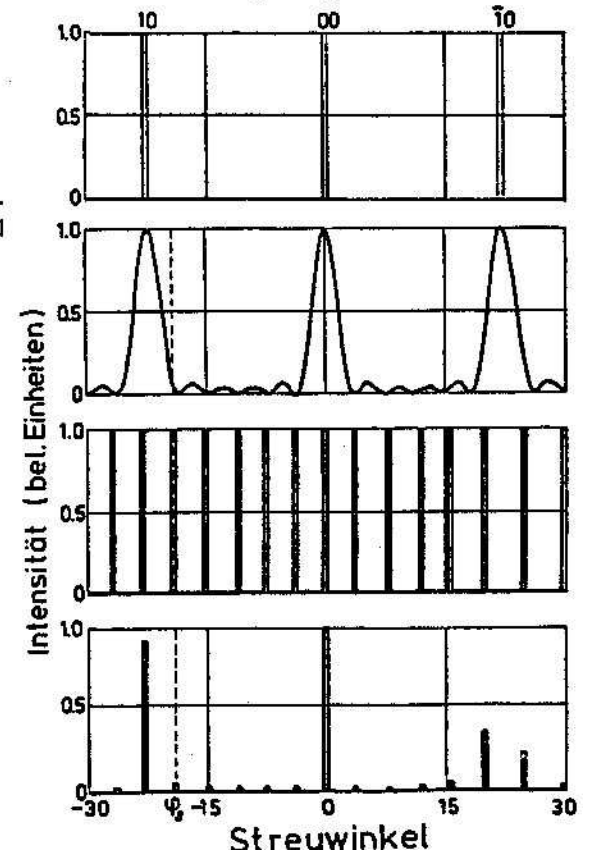

Henzler, Göpel, fig. 3.8.3, p.165

Example: Si(001)vic

Si(001) ↑ [-110]

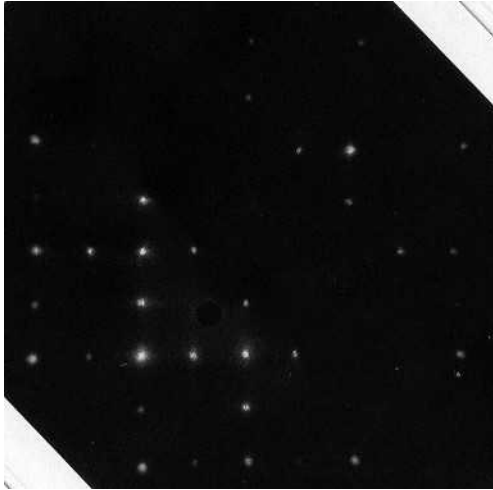

[110]

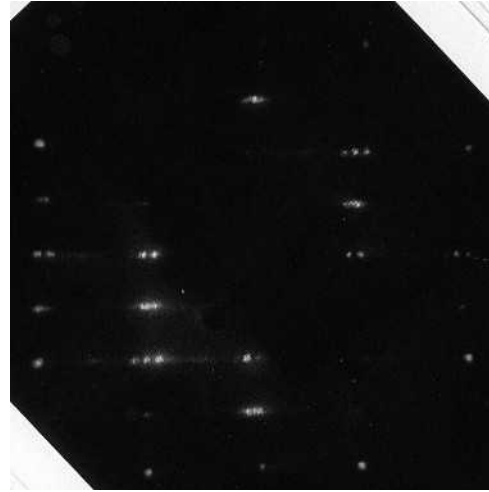

Si(001)vic, 5° → [110]

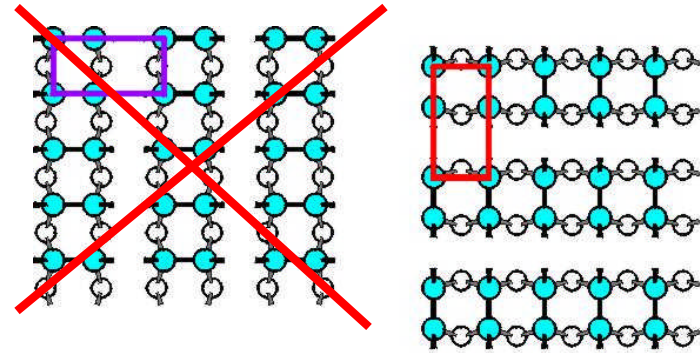

(2x1) and (1x2)

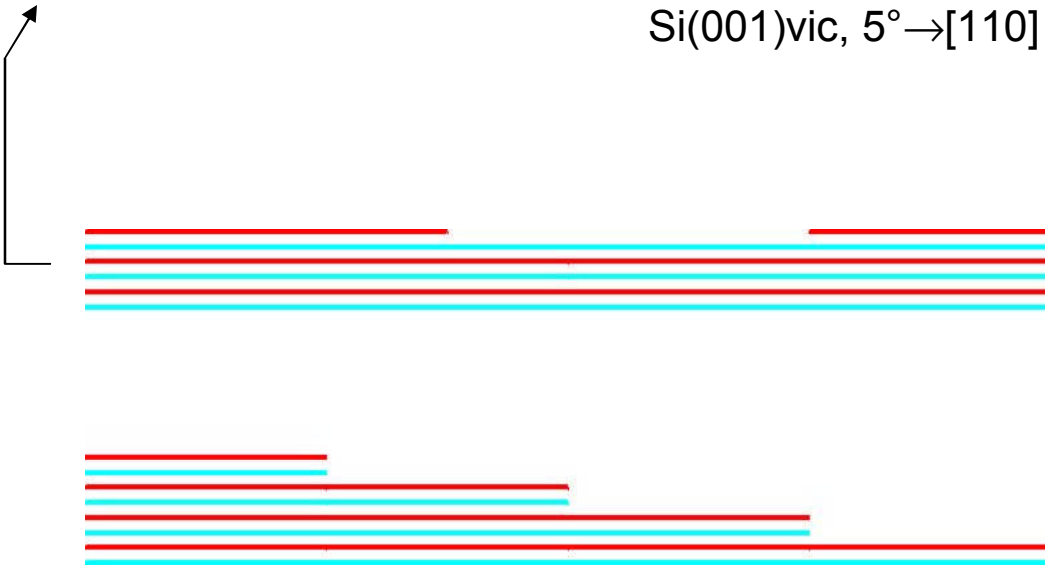
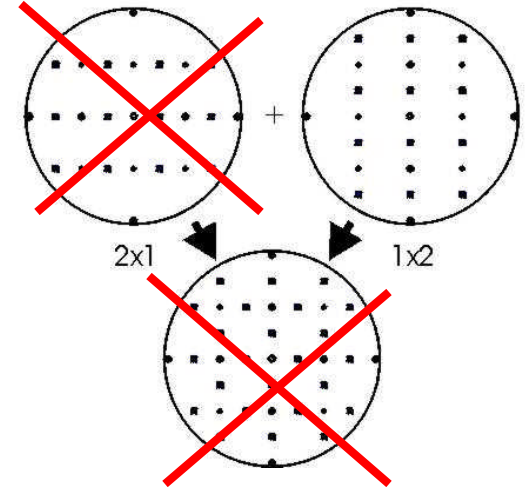

Wasserfall, Ranke, 1994

4. LEED – difficult

Spot intensities contain information on structure within the unit cell

$$I \sim |F|^2 \cdot |G|^2$$

$|G|^2$ = structure factor or **lattice factor**

contains shape and arrangement of repeat units (unit cells)
yields reciprocal lattice
determines location and shape of spots,
kinematic theory

$|F|^2$ = structure factor or **form factor**

contains contribution from all atoms within the repeat unit,
includes multiple scattering, in-depth attenuation,
dynamic theory

Multiple scattering

Henzler/Göpel fig. 3.7.3, p.151

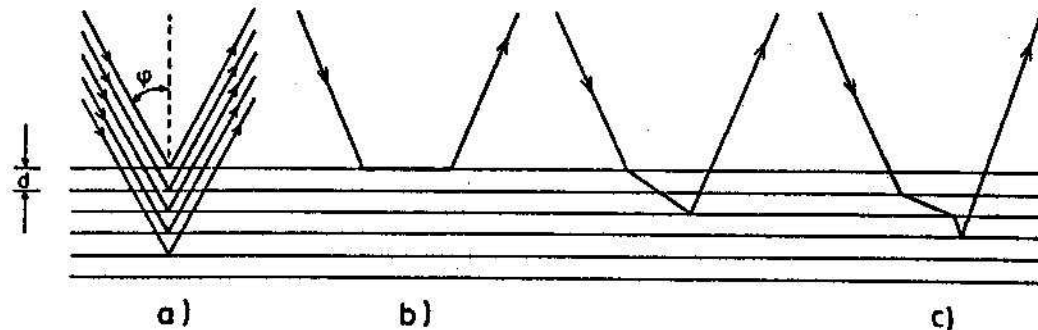

I-V-curve (schem.)

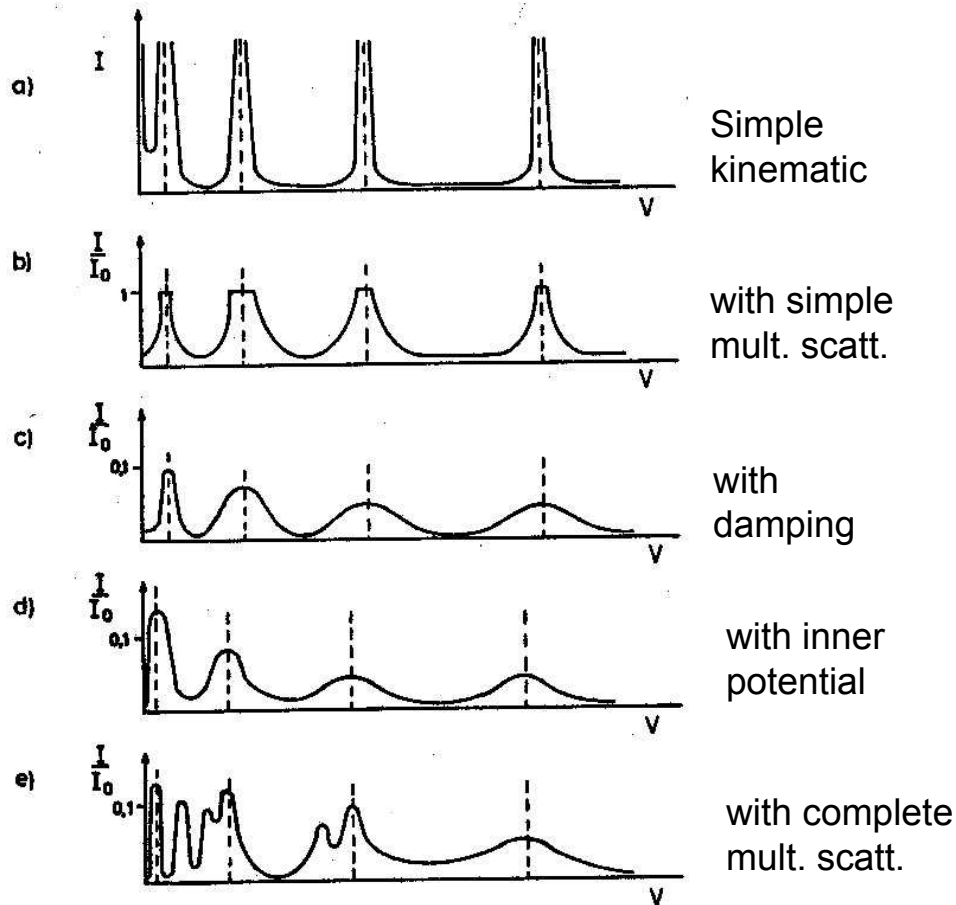

Henzler/Göpel, fig. 3.7.4, p.152

Dynamic LEED analysis:
No direct deduction of structure
from I-V-curves:

Guess structure model
calculate I-V-curves
compare with measured curves
modify model
check if improval
if yes: proceed modifying in this direction
if no: modify in another direction
or guess new model

Disadvantage:
Only for ordered structures
Much computer time

But:
One of very few methods for
structure analysis of first few
atomic layers (~1 nm)

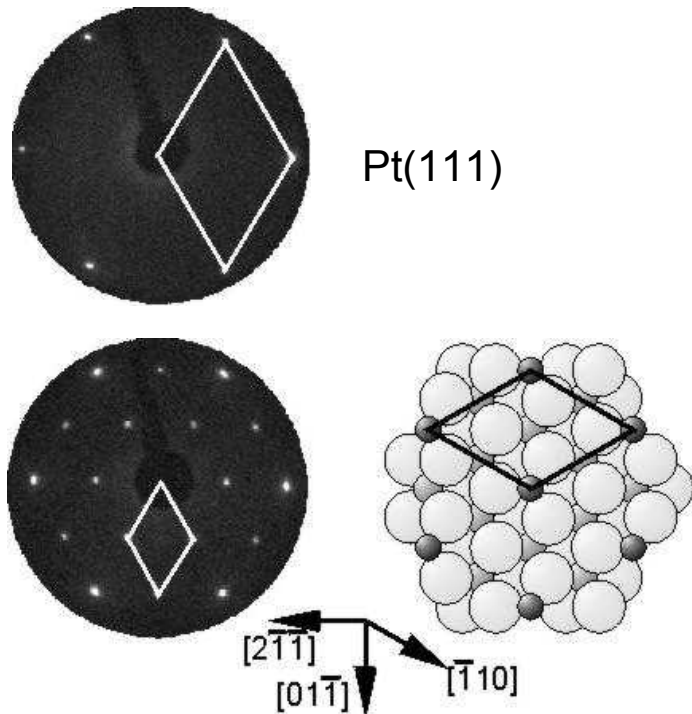

$\text{Fe}_3\text{O}_4(111)$,
(inverse spinel)
10 nm thick
on Pt(111)

LEED-I-V analysis
is one of very few
reliable
surface structure
analysis methods!

Michael Ritter,
Werner Weiss
Guido Ketteler

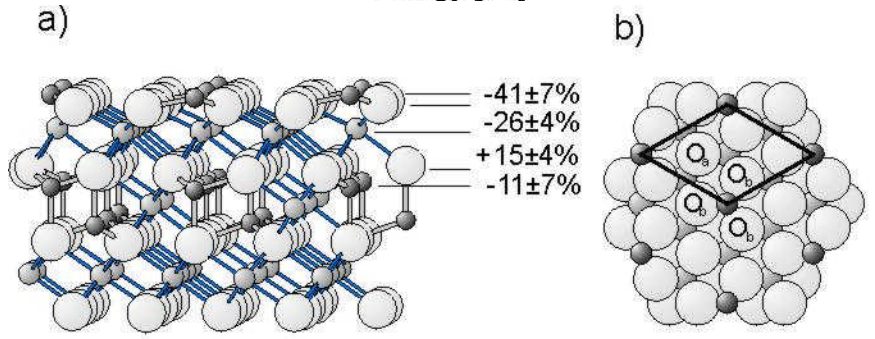
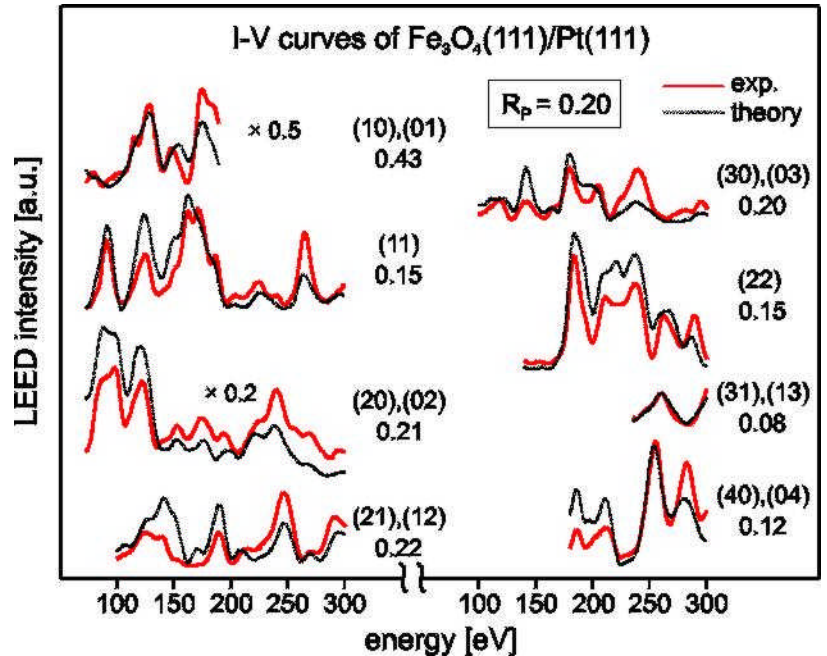

c)

bulk repeat unit	$\text{Fe}_3\text{O}_4(111)$ surface		layer distances [Å]		relaxations [%]
	Fe	O	bulk	surface	
Fe _{tet1}	O _b	d ₁	0.64	0.38±0.05	-41±7
	O _a	b ₁	0.04	0.08±0.09	
Fe _{oct1}	O _b	d ₂	1.18	0.87±0.05	-26±4
	O _a	b ₂	0.04	0.12±0.09	
Fe _{tet2}	O _b	d ₃	1.18	1.36±0.05	+15±4
	O _a	b ₄	0.64	0.57±0.05	
Fe _{oct2}		d ₅	0.60	0.60	0

FeO/Pt(111), satellite pattern: multiple scattering, kinematic

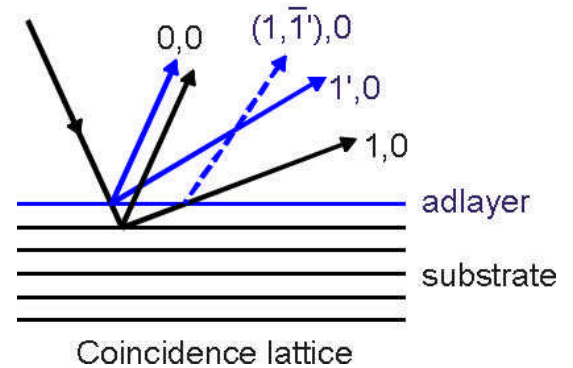
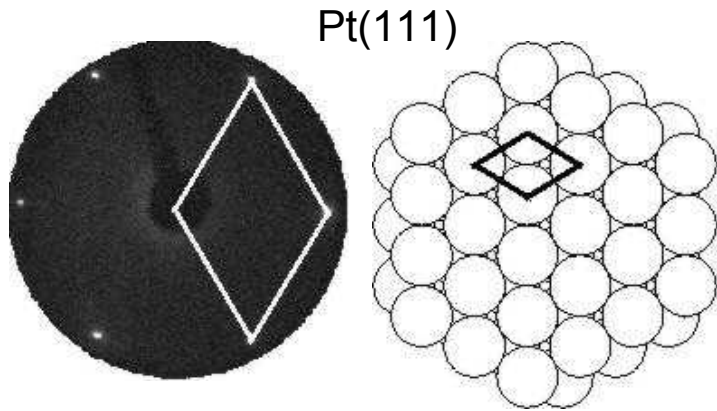

0.9 ML FeO(111) on Pt(111), „structure 1“

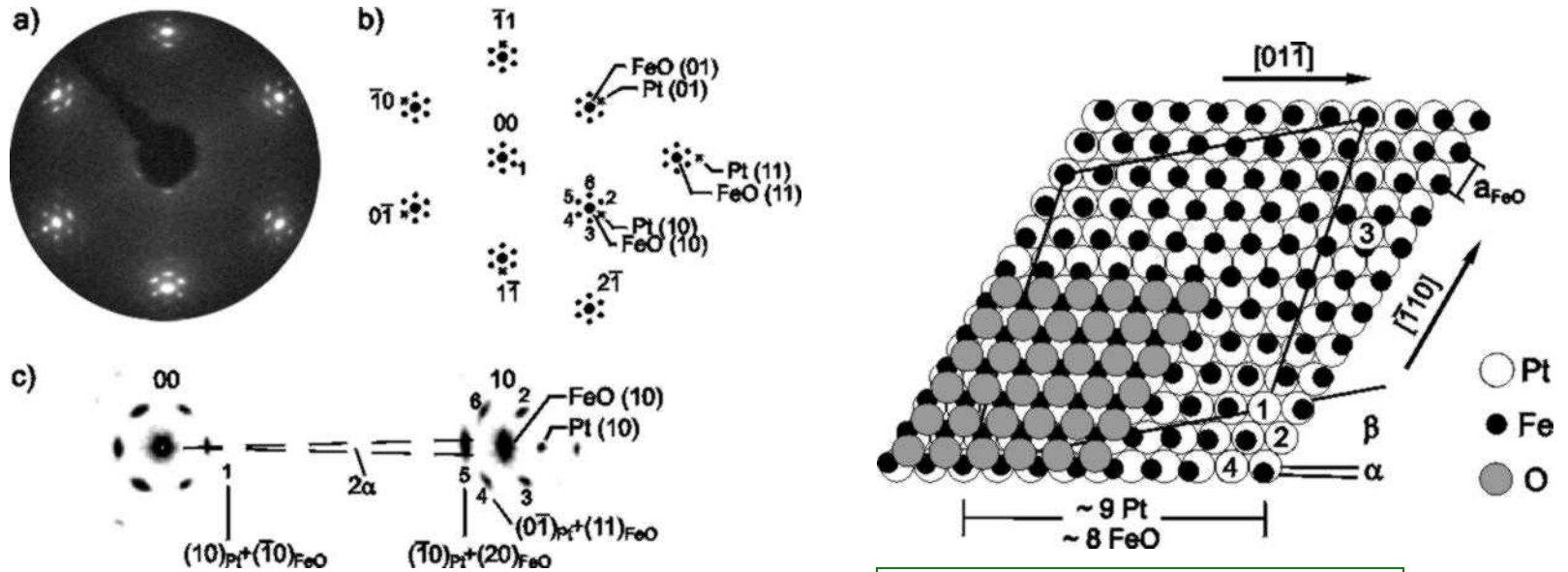

M. Ritter, W. Ranke, W. Weiss

5. LEED in model catalysis - example

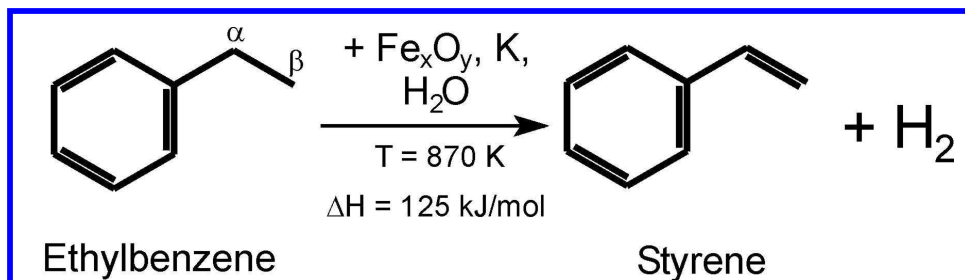
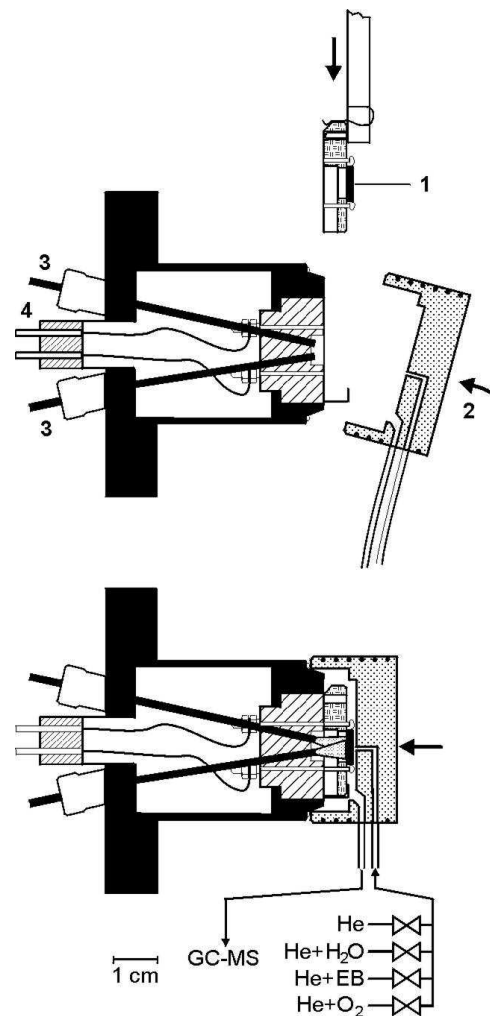
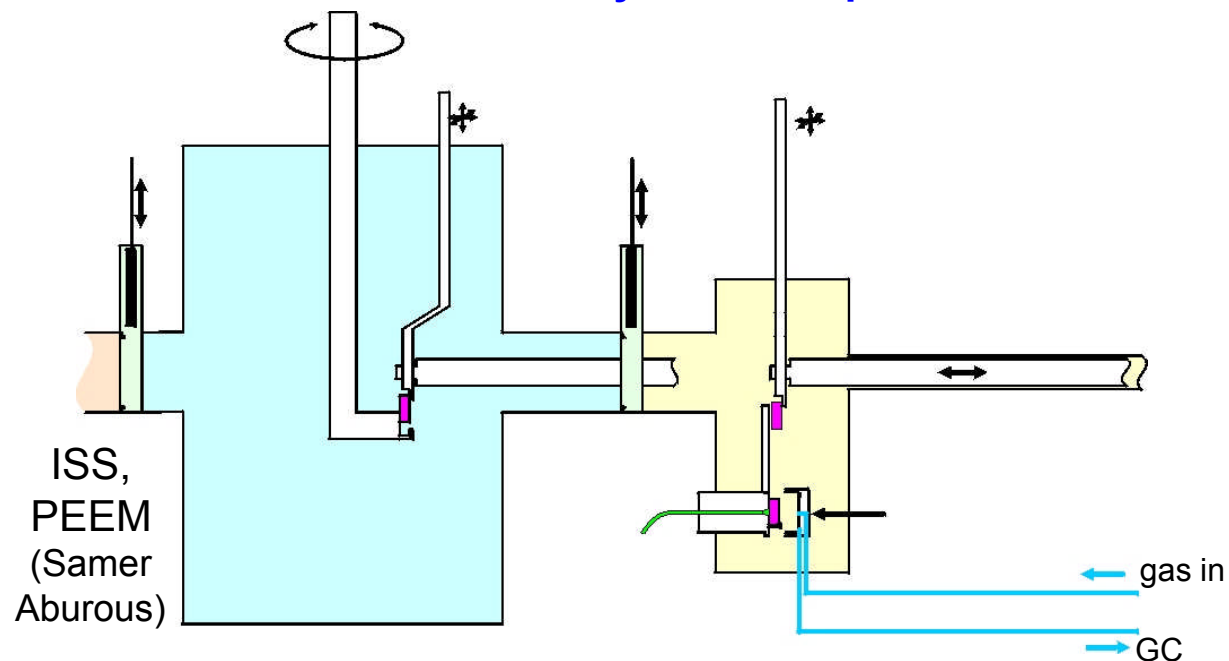

Manfred Swoboda
Christian Kuhrs
Werner Weiss

Distinguish different Fe-O-phases

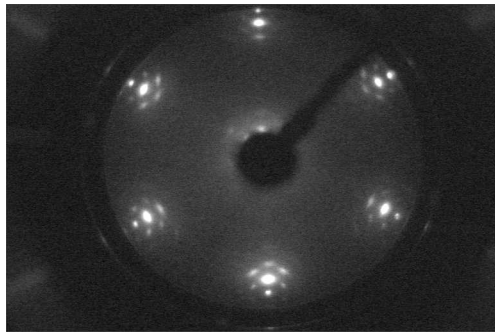

as measured

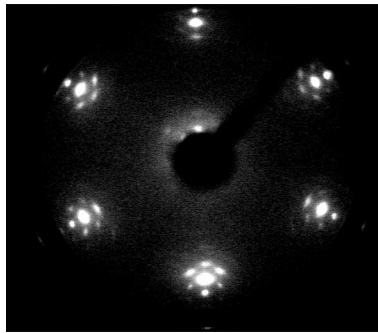

contrast enhanced

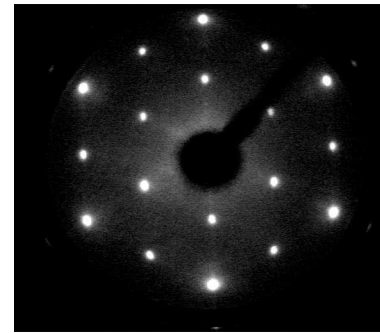

$\text{Fe}_3\text{O}_4(111)$

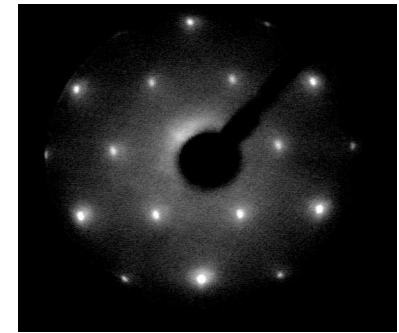

$\alpha\text{-Fe}_2\text{O}_3(0001)$

$\text{FeO}(111)/\text{Pt}(111)$, 1 ML

Change of
order and
phase during
reaction

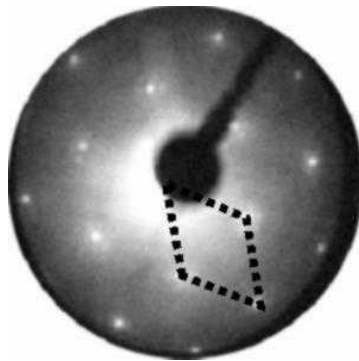

Starting surface:
 $\alpha\text{-Fe}_2\text{O}_3(0001)$
(hematite),
defective

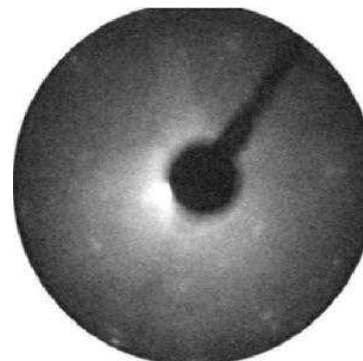

After reaction
- no long-range order
- strong C peak in AES

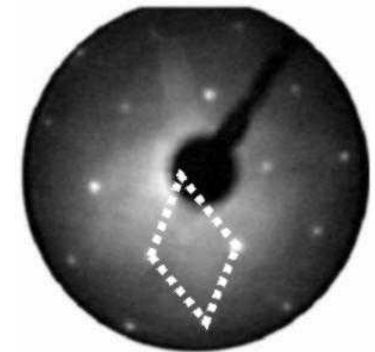

After mild TPO
(thermal programmed
oxidation)
- reordered
- no longer hematite
but $\text{Fe}_3\text{O}_4(111)$
(magnetite)



6. Conclusions

For qualitative information on surface structure very simple (display LEED)

- Order
- Periodicity
- Symmetry

For quantitative information on deviations from ideal order (SPA-LEED)

- Domain size
- Antiphase domains
- atomic steps

For quantitative analysis of surface structure (dynamic I-V-curve analysis)

- Precise atomic arrangements
- Relaxations
- Reconstructions