



Consequence Management Interoperability Services

Introductions & Outline

- **Key Team Member Introductions**
- **Bottom Lines Up Front**
- **The Problem**
- **The Proposed Solution**
 - **What**
 - **Why**
 - **Who**
 - **Where**
 - **When**
- **Bottom Lines Again**



Bottom Lines Up Front

- **CMI-Services is a bottom-up, stakeholder-driven effort**
- **We seek involvement by YOU:**
 - Visit us at <http://www.cmi-services.org>
 - Engage in threaded discussions
 - Complete surveys

We need to know:

- **YOUR** needs
- **YOUR** priorities



The Problem

Federal



**State /
Region**



Local





The Proposed Solution - What

Federal



**State /
Region**



Local

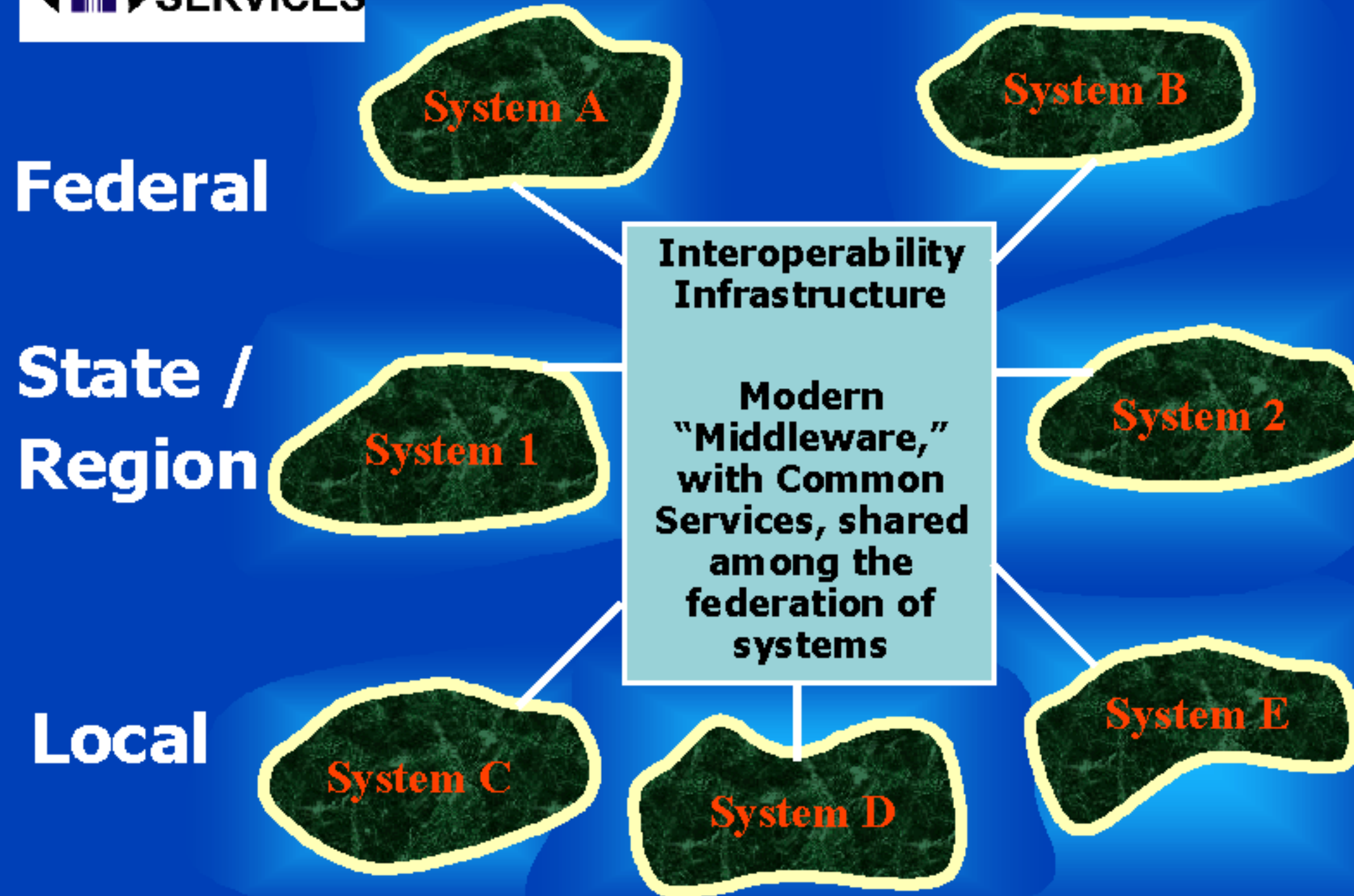

The Proposed Solution - Why

Traditional Interface Proliferation

2 Systems = 1 Interface

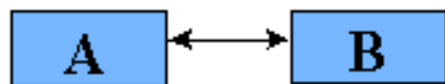

3 Systems = 3 Interfaces

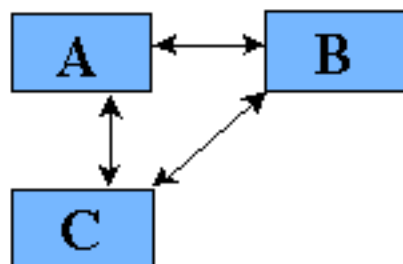

4 Systems = 6 Interfaces

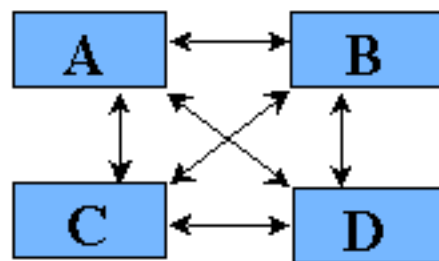

5 Systems = 10 Interfaces

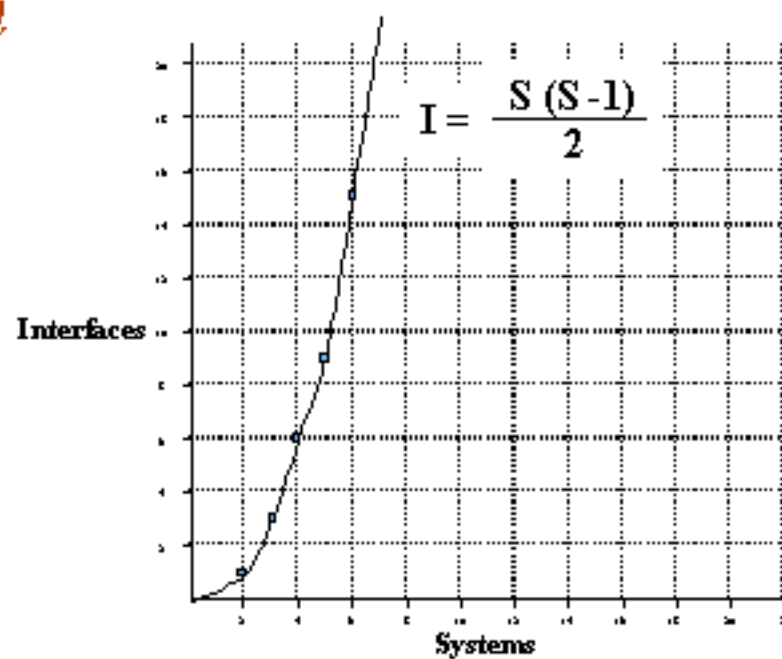
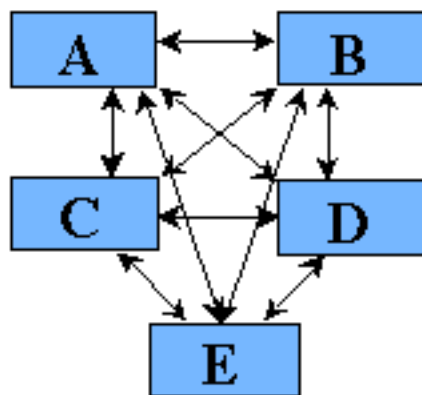

- Every change spawns a geometric progression of interface analyses
- Data Quality suffers

**Unaffordable
Unmanageable**

Middleware Approach

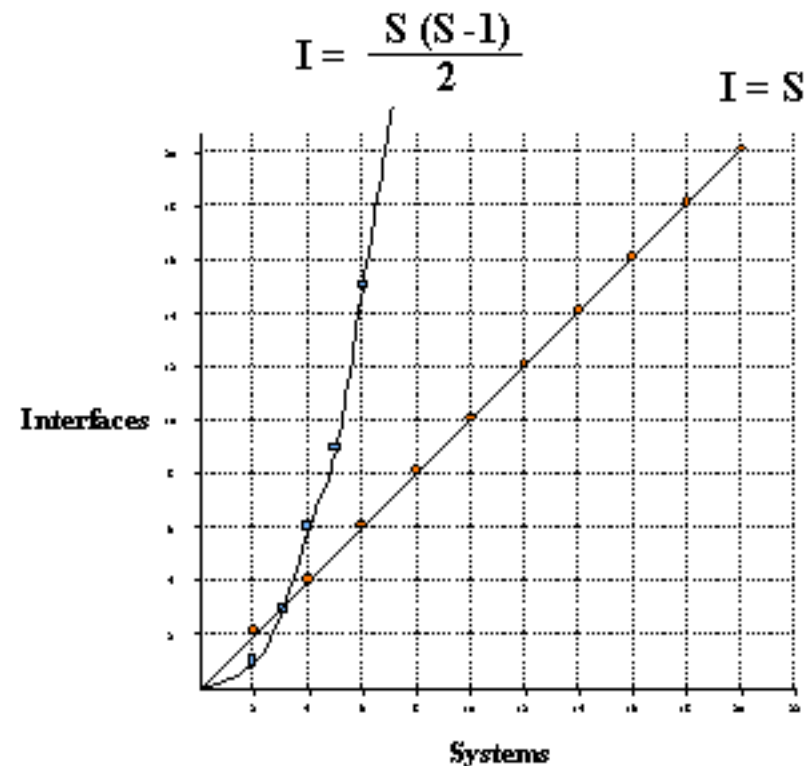
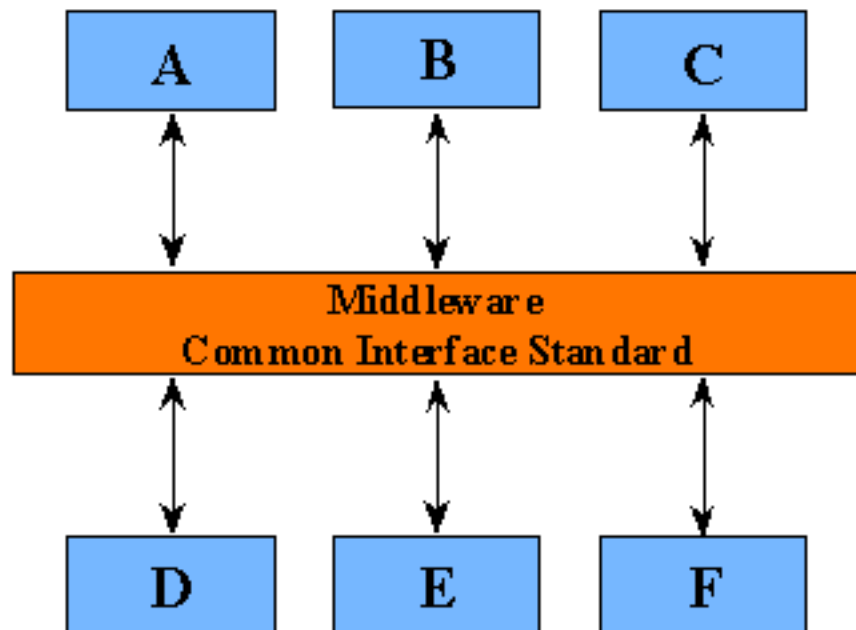

•1 Interface per System

•Change limited to 1 Interface

**Cost/time Savings
Better Data Quality**



The Proposed Solution - Who

- **Government Executive Agent - USMC Systems Command**
- **Government Program Manager - Mr. Doug Bryce**
- **Support Team - Battelle (prime), Veridian, MTS, Sverdrup**
- **Advisory Bodies - InterAgency Board, Executive Interoperability Council**
- **Individual Stakeholders - over 200 interviews to date per next slide**
- **Stakeholder Organizations - National Institute for Urban Search and Rescue (NI/USR), Emergency Information Infrastructure Partnership, multiple agencies per slide # 9**
- **Potential Collaborators - NI/USR eXtreme Interoperability Infrastructure project and Project Atlanta so far**



The Proposed Solution - Who

Requirements Elicitation

Local Stakeholder Interview Target Cities

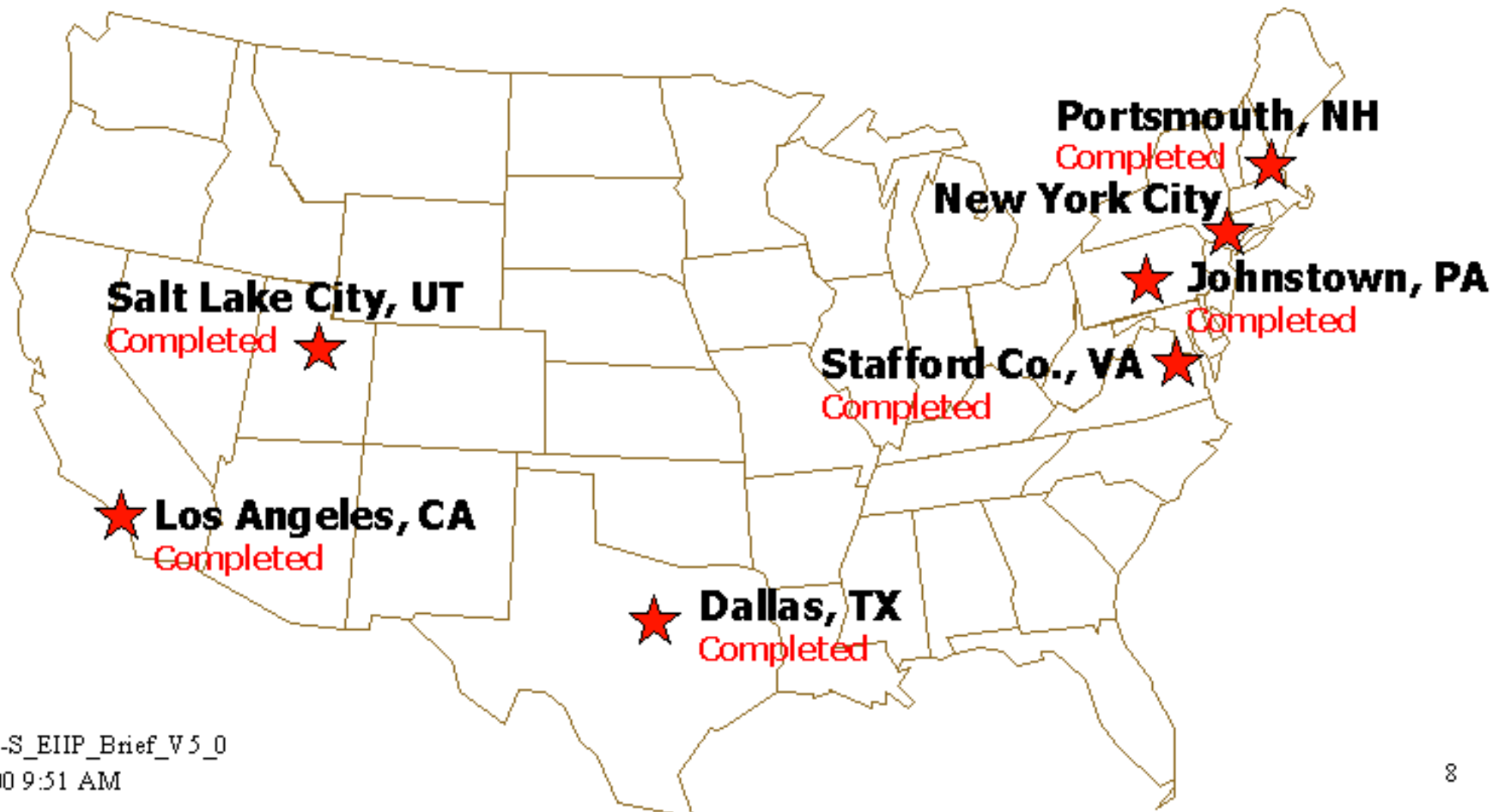



The Proposed Solution - Who

Requirements Elicitation

Federal Stakeholder Briefing/Interview Target Agencies

- 1st Civil Support Detachment – Natick, MA**
- SBCCOM – Technical Escort Unit**
- USMC CBIRF**
- Federal Emergency Management Agency**
- Department of Justice**
- National Guard Bureau**
- Centers for Disease Control**
- National Disaster Medical System**
- Department of Energy**
- Department of Agriculture**
- DASD Reserve Affairs (Military Support to Civil Authorities)**
- JTF – Civil Support**
- USCG Strike Teams**

Bottom Lines Again

- **CMI-Services is a bottom-up, stakeholder-driven effort**
- **We seek involvement by YOU:**
 - Visit us at <http://www.cmi-services.org>
 - Engage in threaded discussions
 - Complete surveys

We need to know:

- **YOUR** needs
- **YOUR** priorities